

OPUS		Lonena aust (46312021003)		
		PLANFLATE 1		
		Interne vegar		
		Tverrprofil Veg 1		
Stad:	Bergen	Prosj.nr.	Teikn.nr.	Rev.
Dato:	10.06.22	21000	U101	-
Målestokk:	1:100(A1)			
Pros.ansv.:	HH			
Teikna av:	TV			
Kontrollert av:	EB			

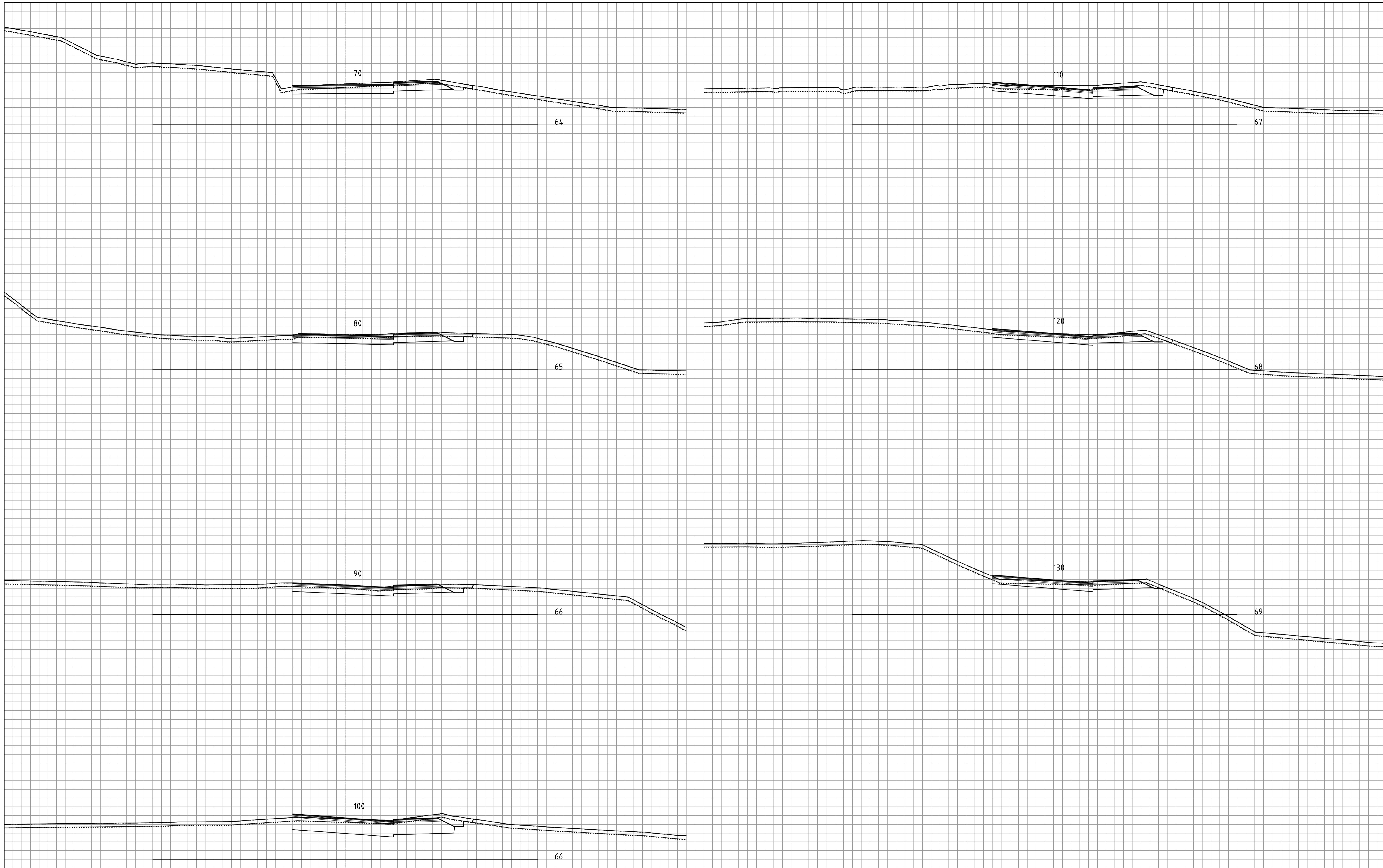

OPUS

Lonena aust (46312021003)
 PLANFLATE 1
 Interne vegar

Tverrprofil Veg 1

Stad:	Bergen	Proj.nr.	Teikn.nr.	Rev.
Dato:	10.06.22	21000	U102	-
Målestokk:	1:100(A1)			
Pros.ansv.:	HH			
Teikna av:	TV			
Kontrollert av:	EB			

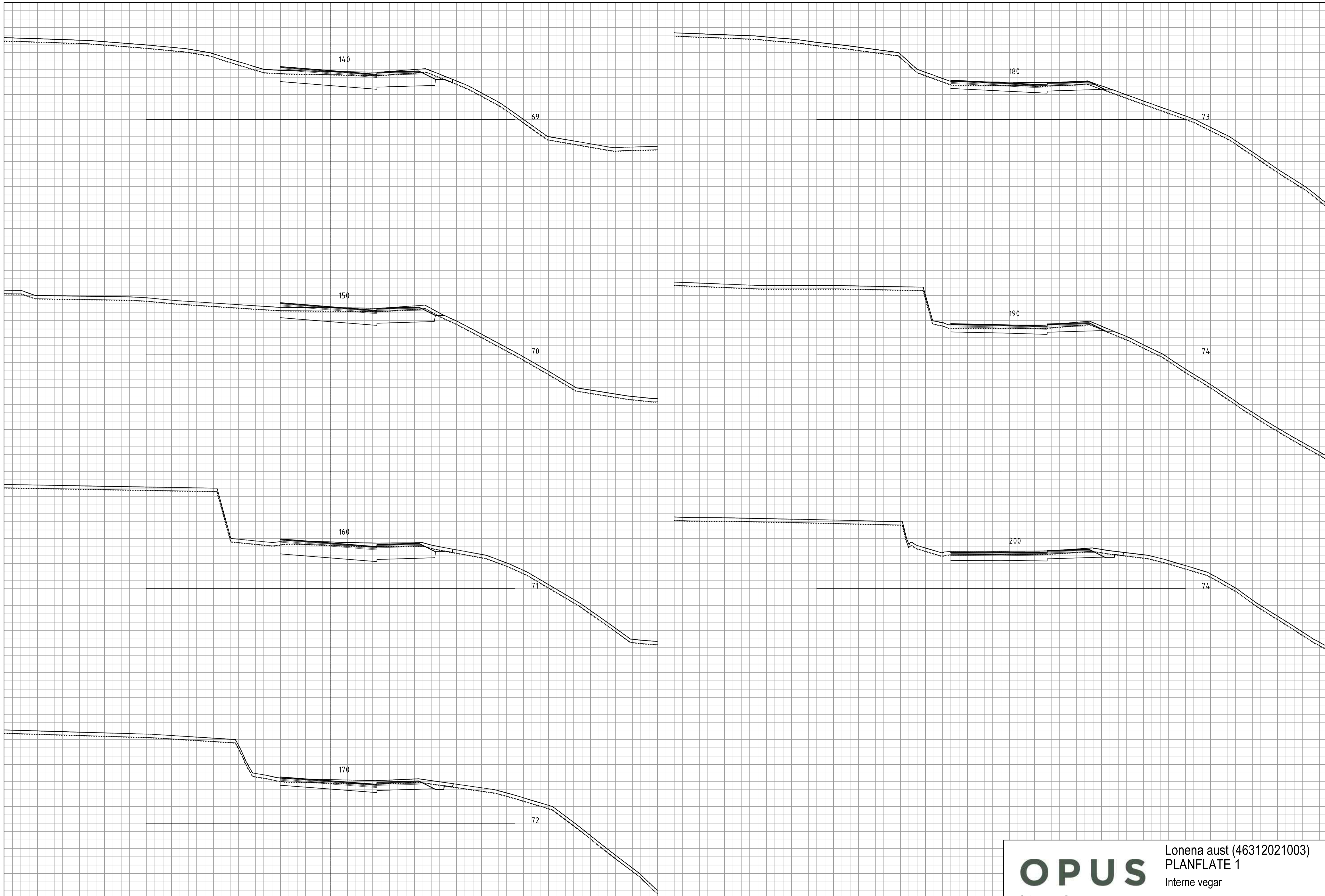

OPUS		Lonena aust (46312021003)		
		PLANFLATE 1		
		Interne vegar		
		Tverrprofil Veg 1		
Stad:	Bergen	Proj.nr.	Teikn.nr.	Rev.
Dato:	10.06.22	21000	U103	-
Målestokk:	1:100(A1)			
Pros.anstv.:	HH			
Teikna av:	TV			
Kontrollert av:	EB			

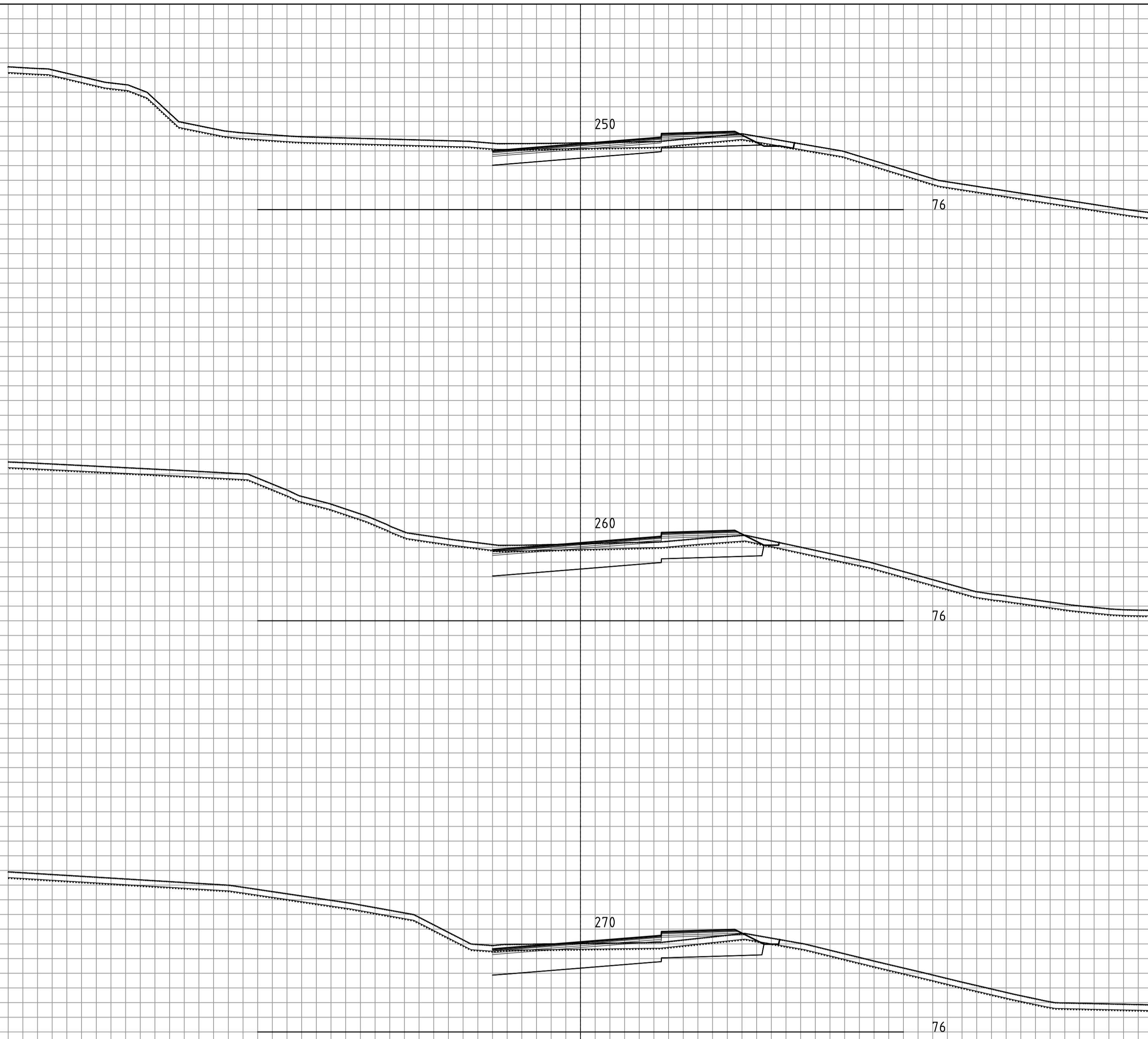
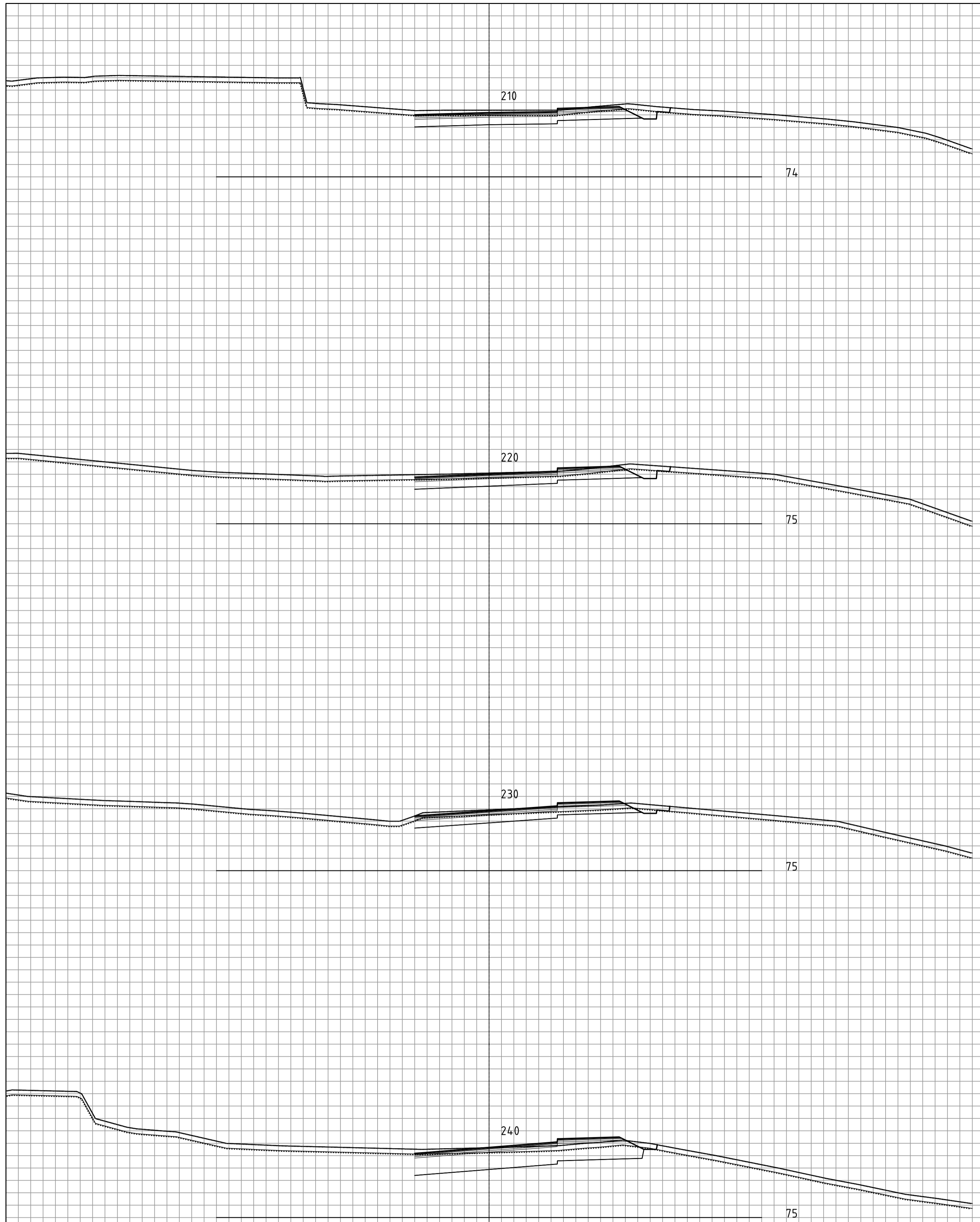

OPUS		Lonena aust (46312021003)					
		PLANFLATE 1					
		Interne vegar					
		Tverrprofil Veg 1					
Stad:	Bergen	Prosj.nr.	21000	Teikn.nr.	U104	Rev.	-
Dato:	10.06.22						
Målestokk:	1:100(A1)						
Pros.ansv.:	HH						
Teikna av:	TV						
Kontrollert av:	EB						

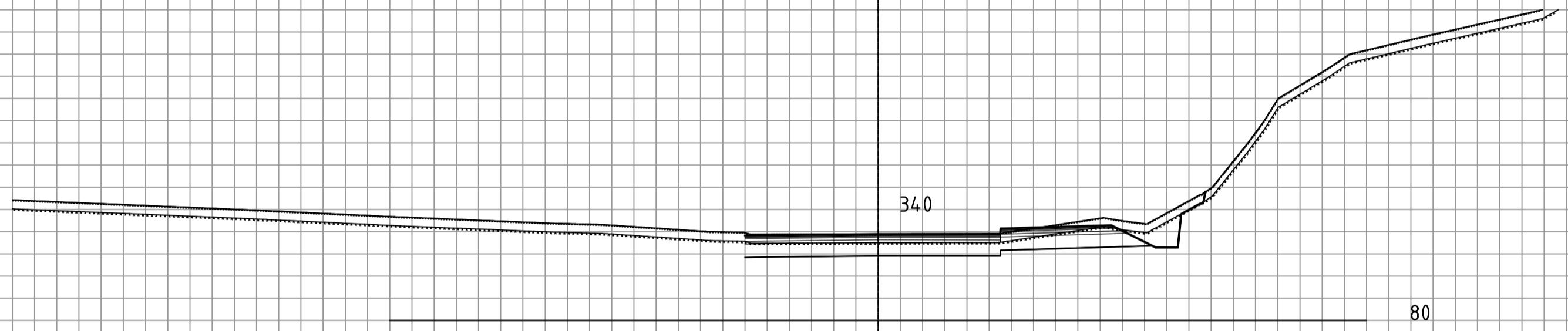
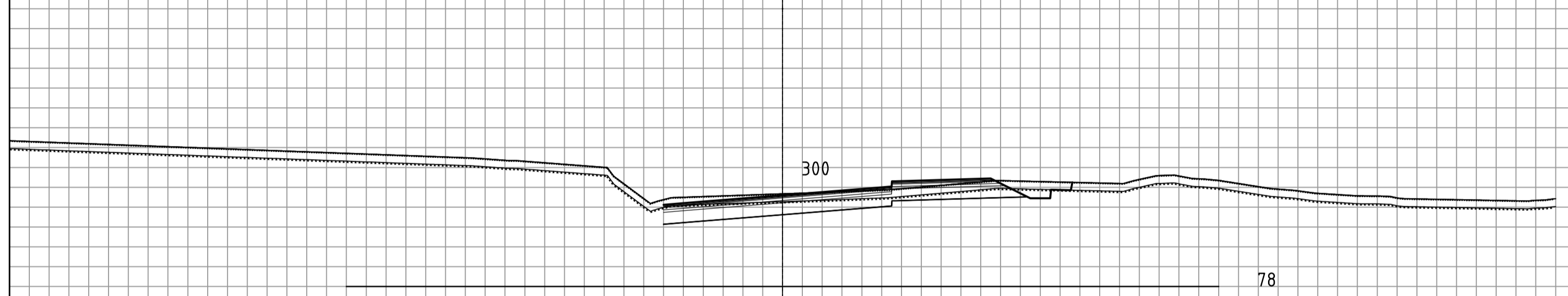
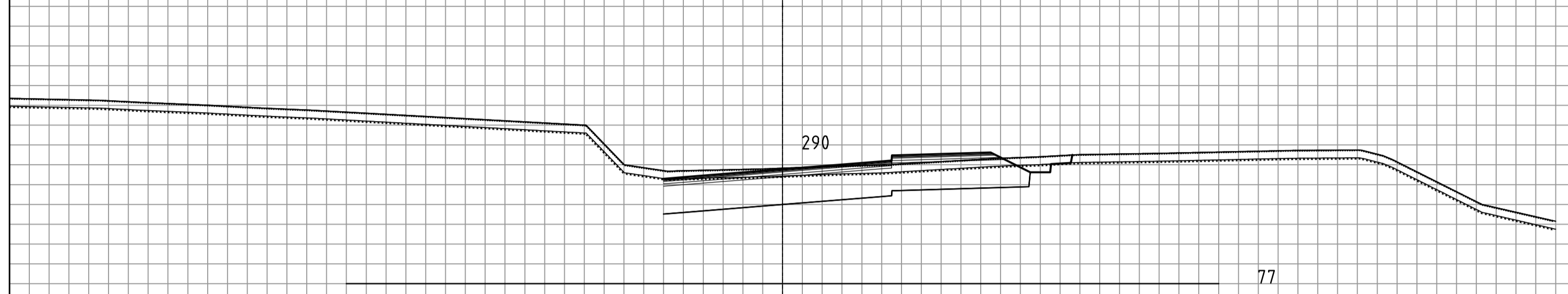
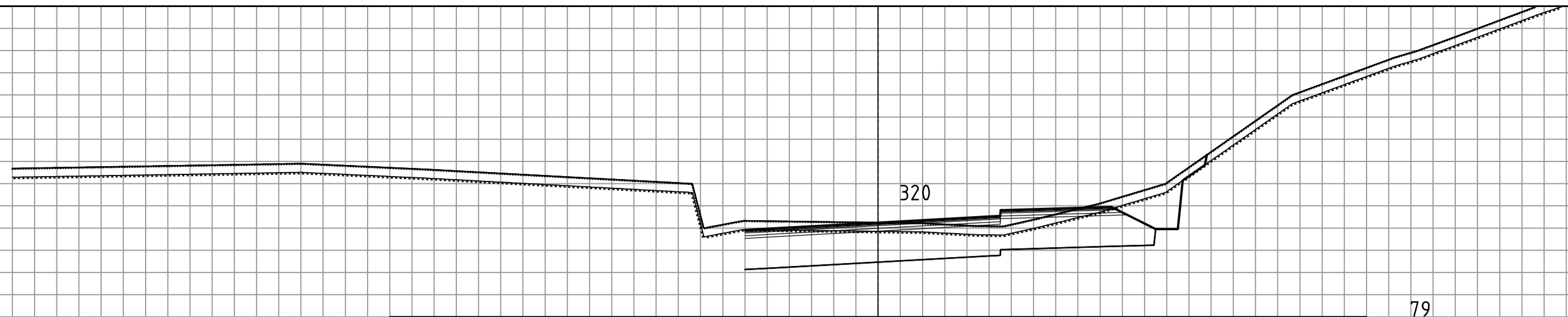
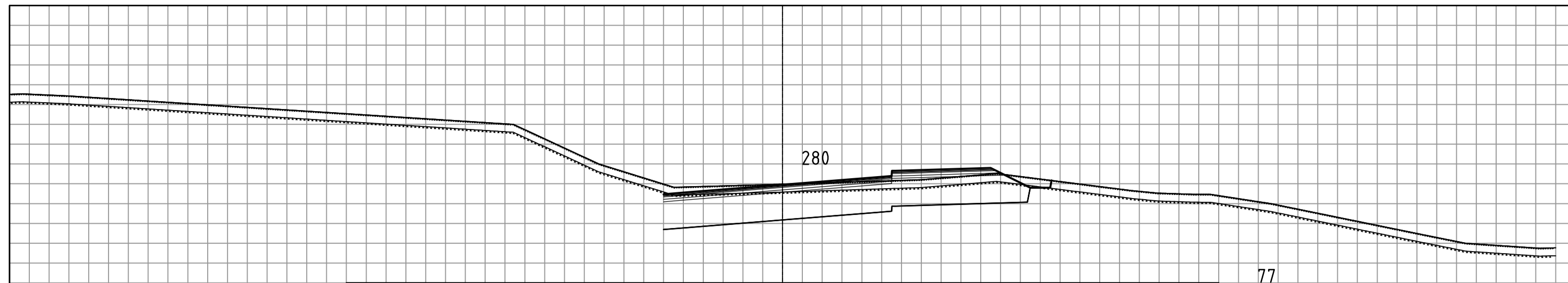

OPUS

Stad: Bergen
 Dato: 10.06.22
 Målestokk: 1:100(A1)
 Pros.ansv.: HH
 Teikna av: TV
 Kontrollert av: EB

Lonena aust (46312021003)
 PLANFLATE 1
 Interne vegar

Tverrprofil Veg 1

Prosj.nr. 21000
 Teikn.nr. U105
 Rev. -

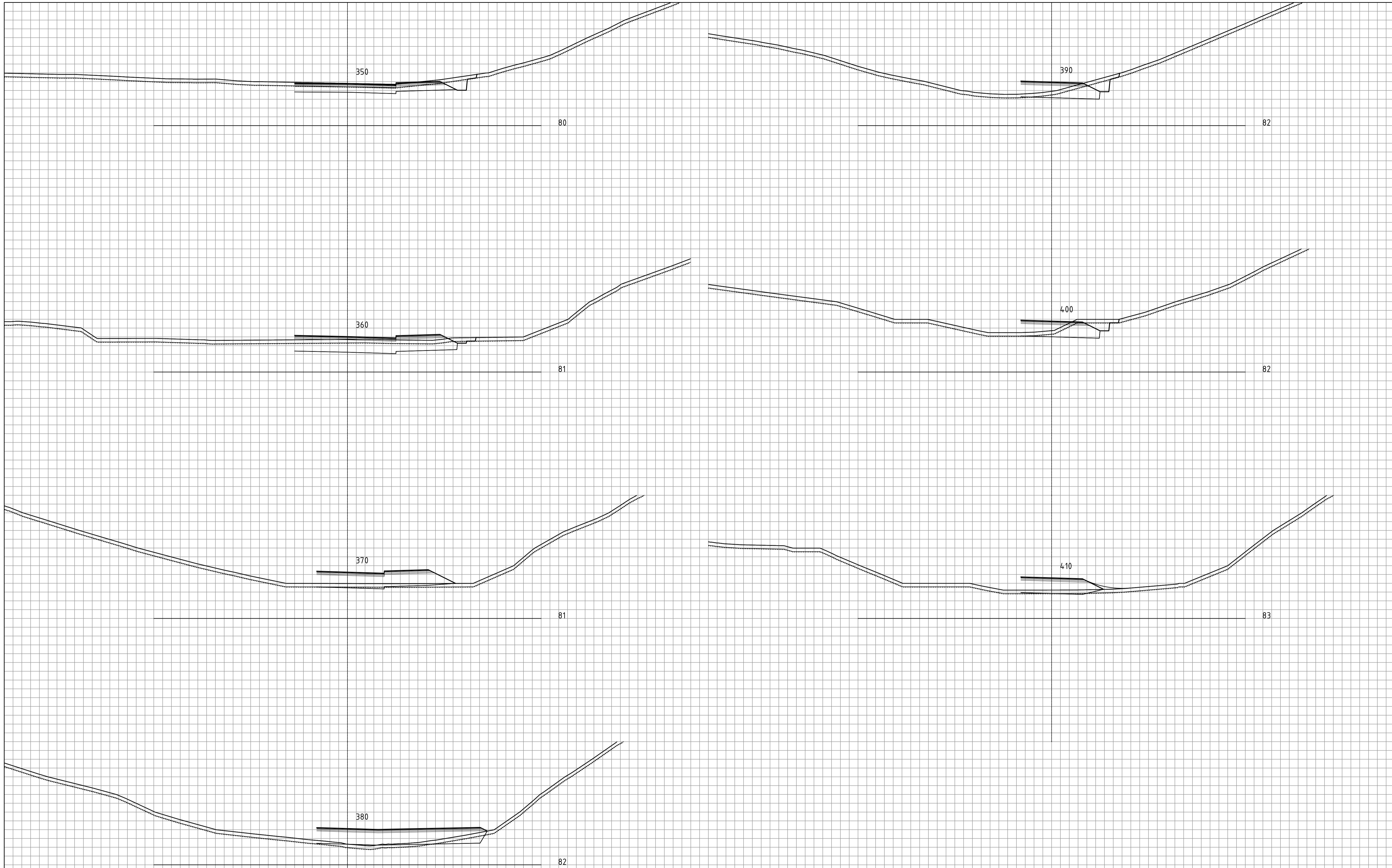

OPUS		Lonena aust (46312021003)	
		PLANFLATE 1	
		Interne vegar	
		Tverrprofil Veg 1	
Stad:	Bergen	Prosj.nr.	Teikn.nr.
Dato:	10.06.22	21000	U106
Målestokk:	1:100(A1)		
Pros.ansv.:	HH		
Teikna av:	TV		
Kontrollert av:	EB		

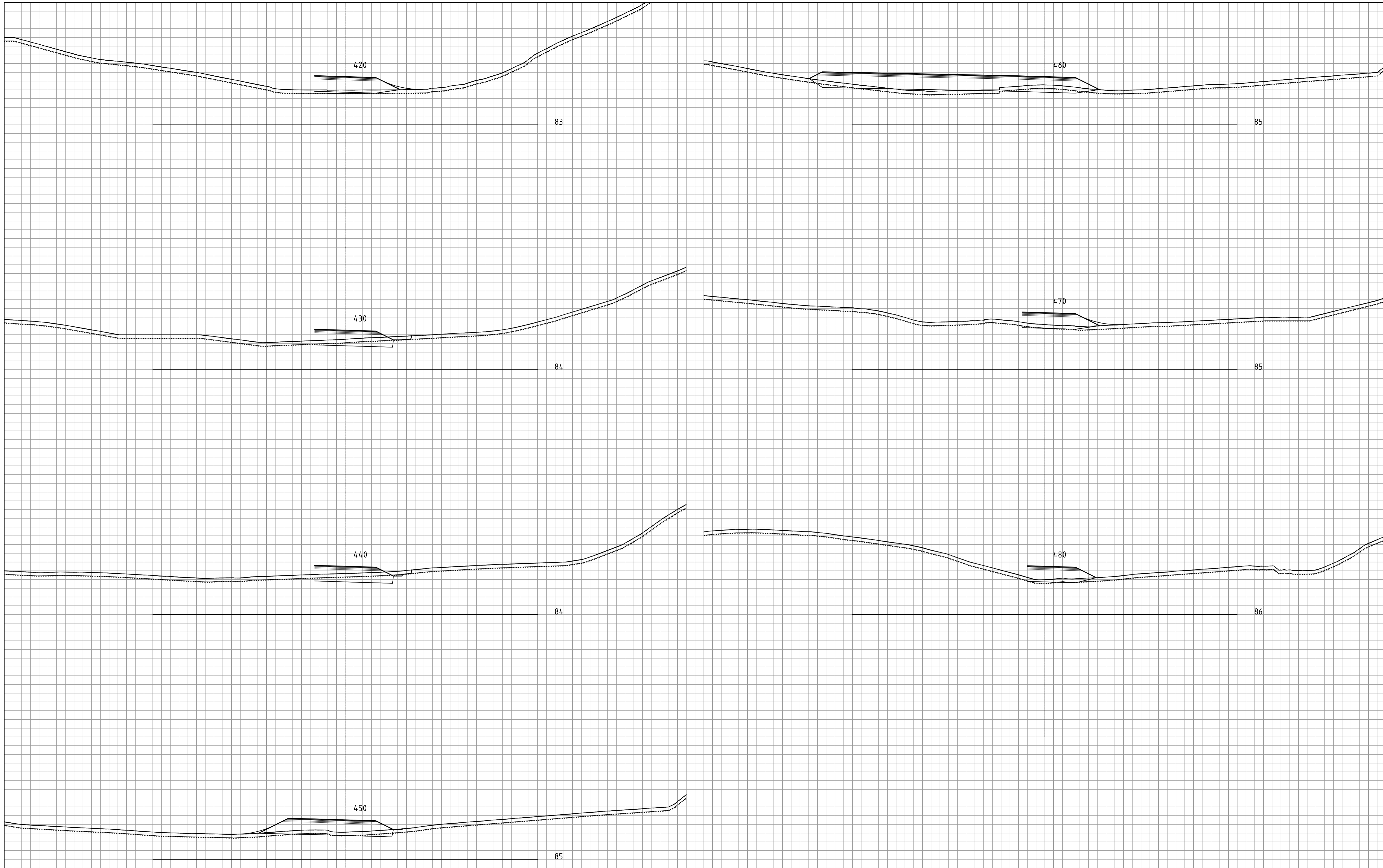

OPUS		Lonena aust (46312021003)	
		PLANFLATE 1	
		Interne vegar	
		Tverrprofil Veg 1	
Stad:	Bergen	Prosj.nr.	Teikn.nr.
Dato:	10.06.22	21000	U107
Målestokk:	1:100(A1)		
Prosj.ansv.:	HH		
Teikna av:	TV		
Kontrollert av:	EB		

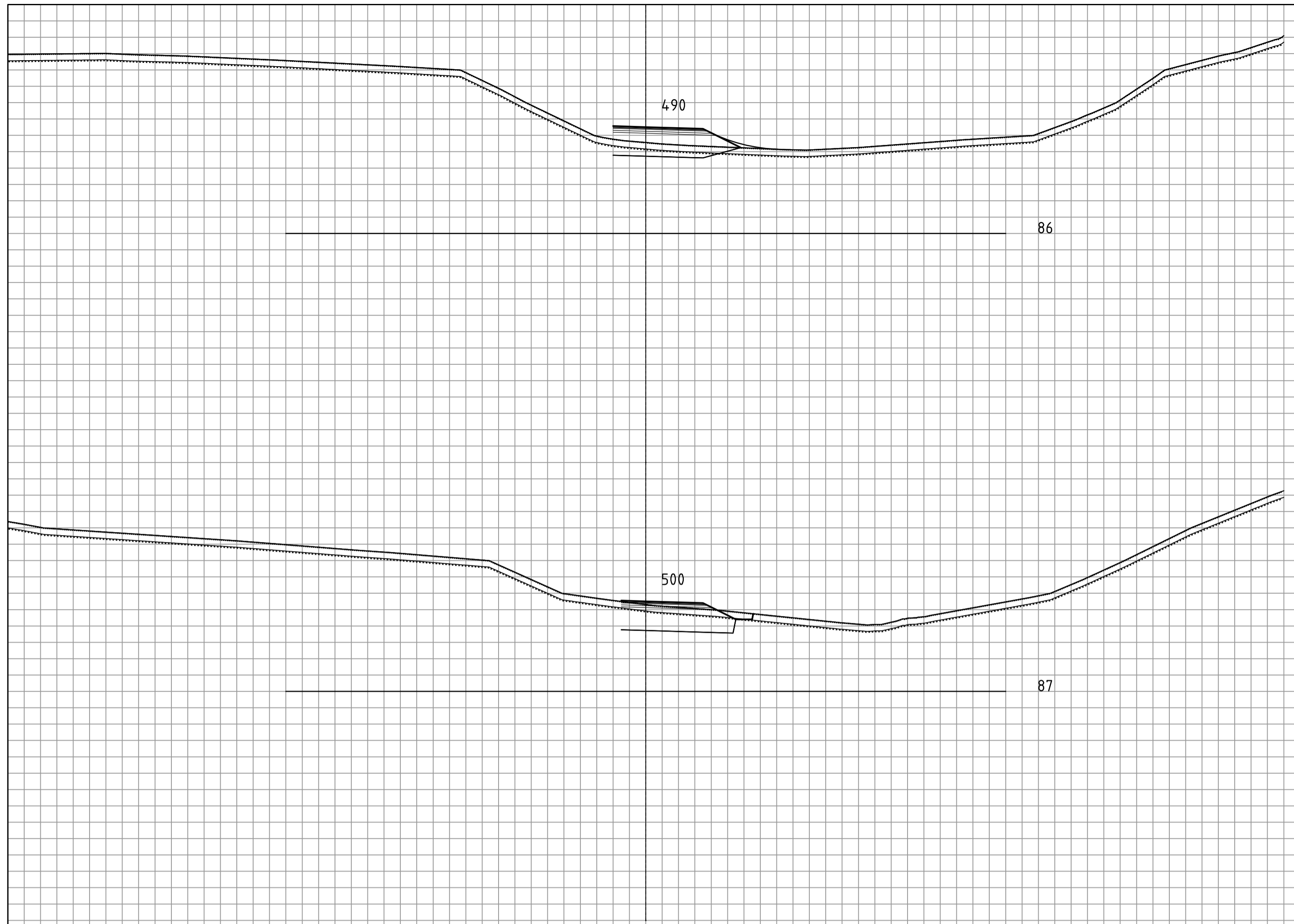

OPUS

Lonena aust (46312021003)
 PLANFLATE 1
 Interne vegar

Stad: Bergen
 Dato: 10.06.22
 Målestokk: 1:100(A1)
 Pros.ansv.: HH
 Teikna av: TV
 Kontrollert av: EB

Tverrprofil Veg 1

Prosj.nr.
 21000

Teikn.nr. Rev.
 U108 -

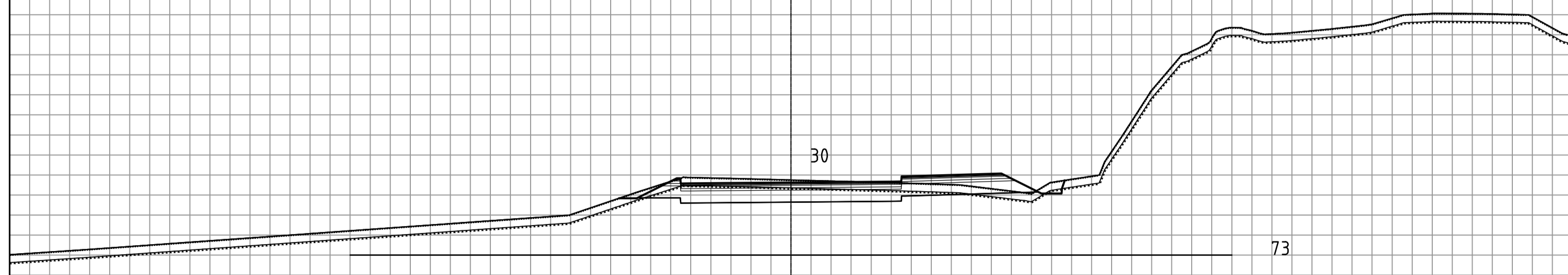
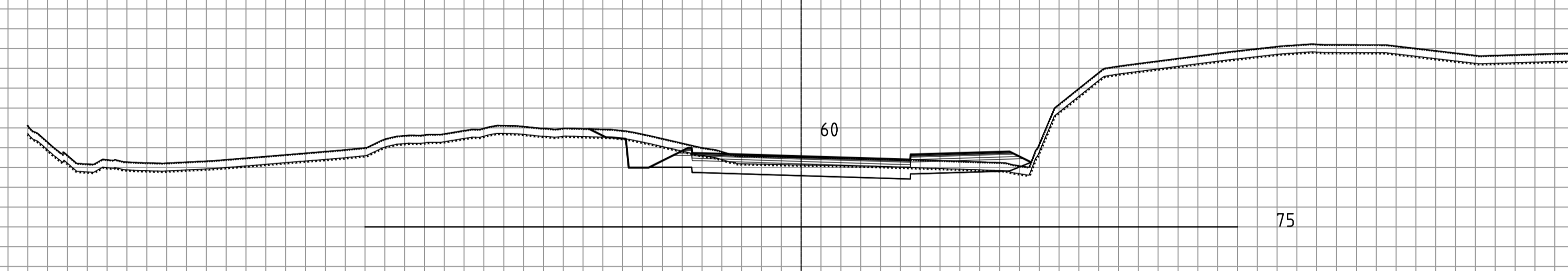
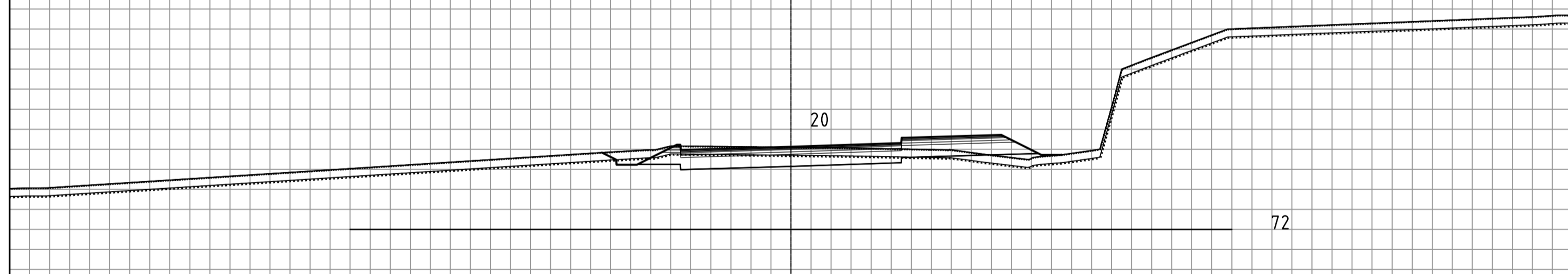
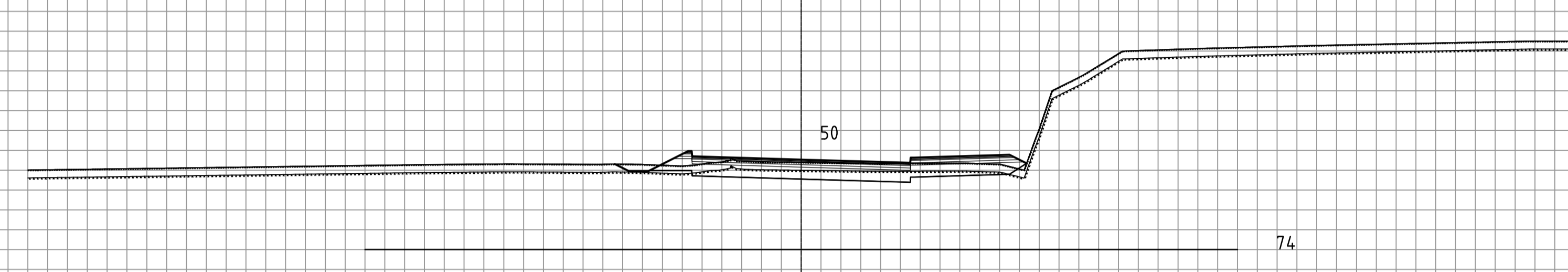
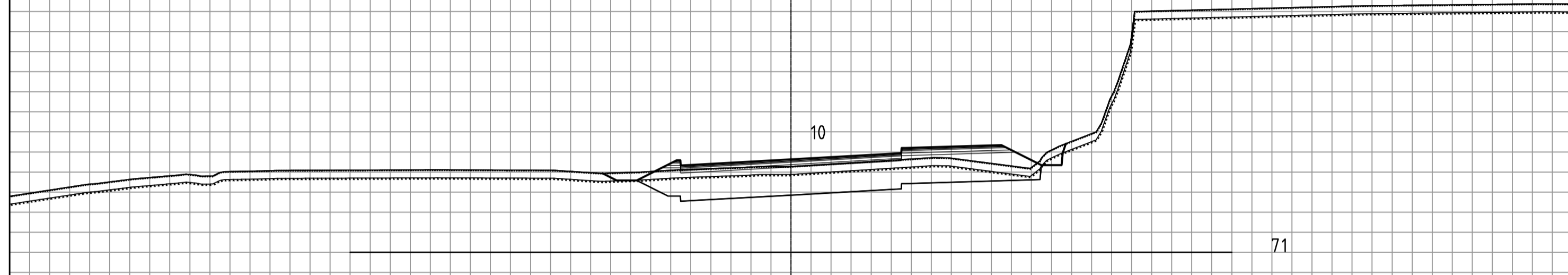
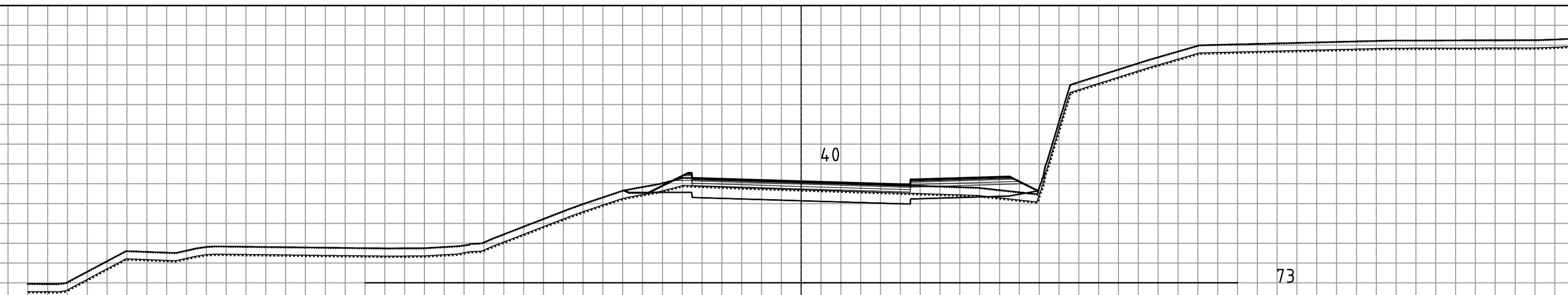
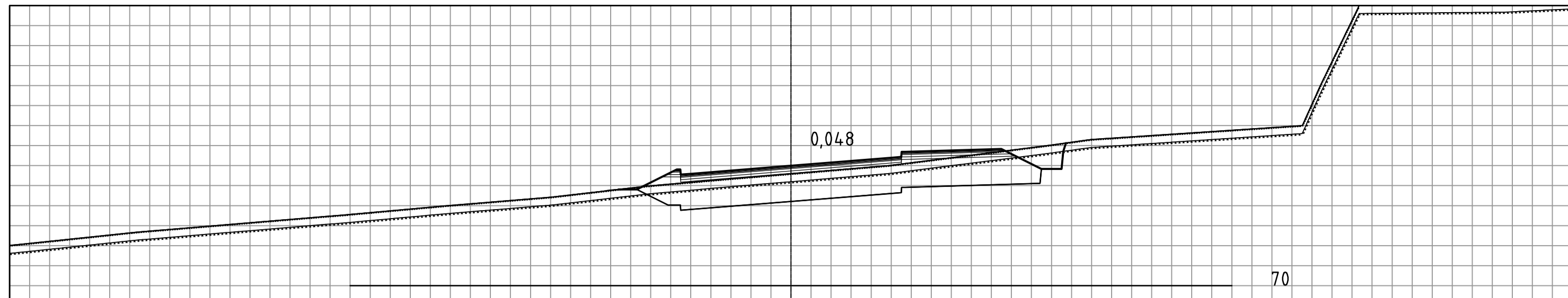

OPUS

Stad: Bergen
 Dato: 10.06.22
 Målestokk: 1:100(A1)
 Pros.anstv.: HH
 Teikna av: TV
 Kontrollert av: EB

Lonena aust (46312021003)
 PLANFLATE 1
 Interne vegar

Tverrprofil Veg 2

Prosj.nr.	Teikn.nr.	Rev.
21000	U109	-

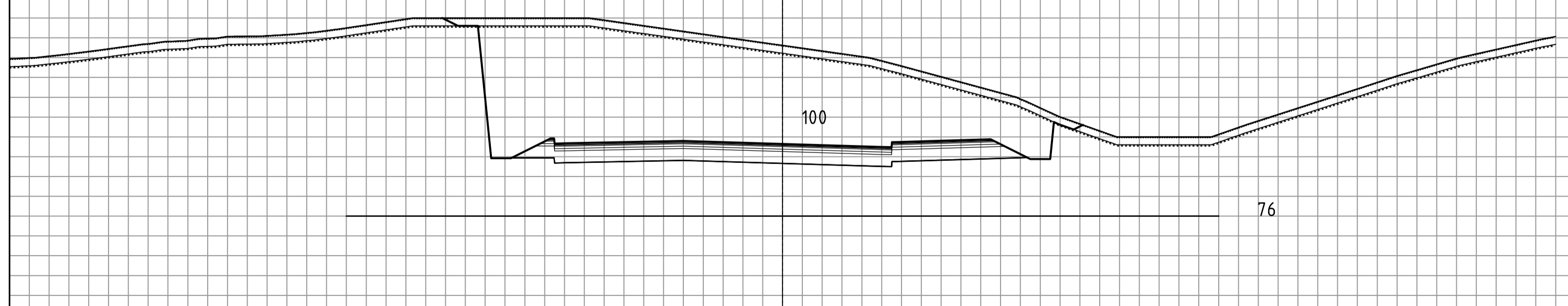
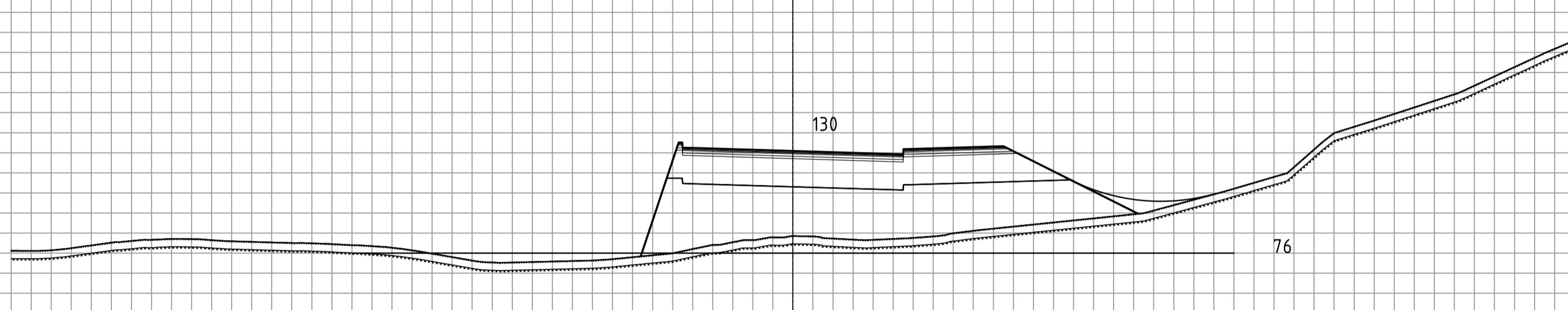
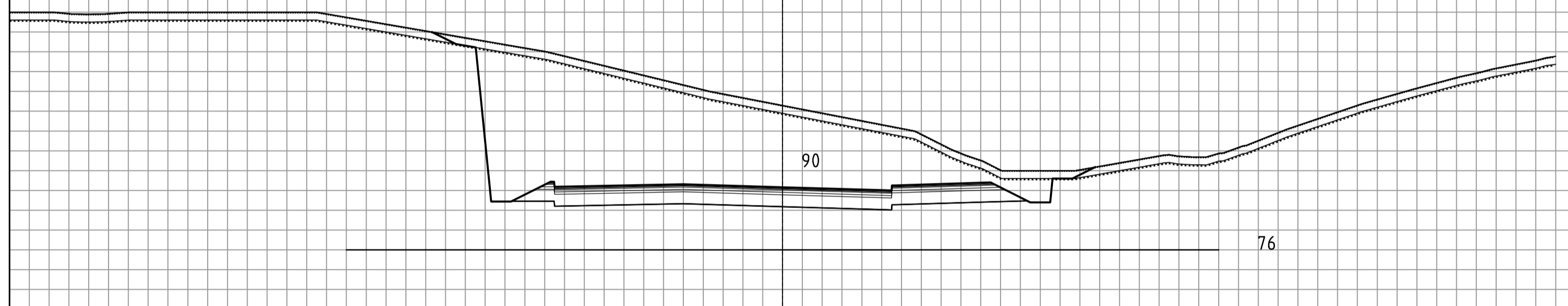
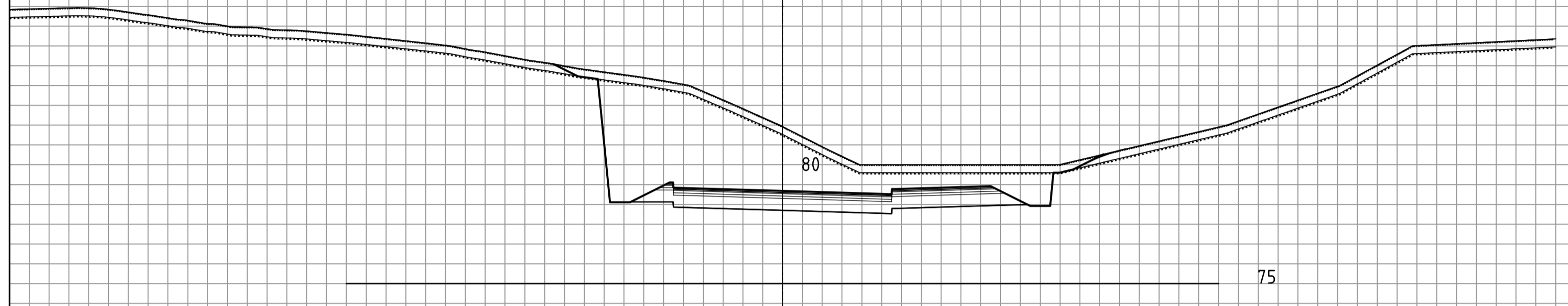
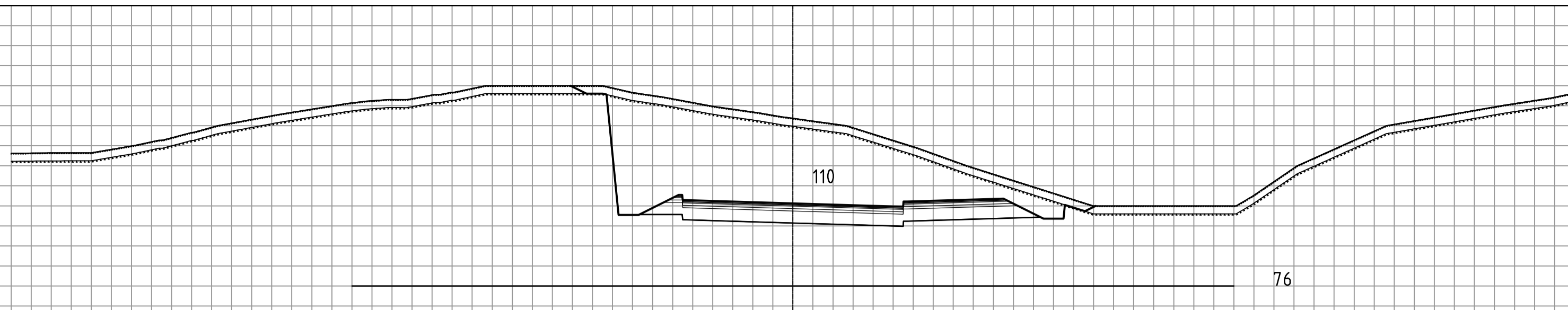
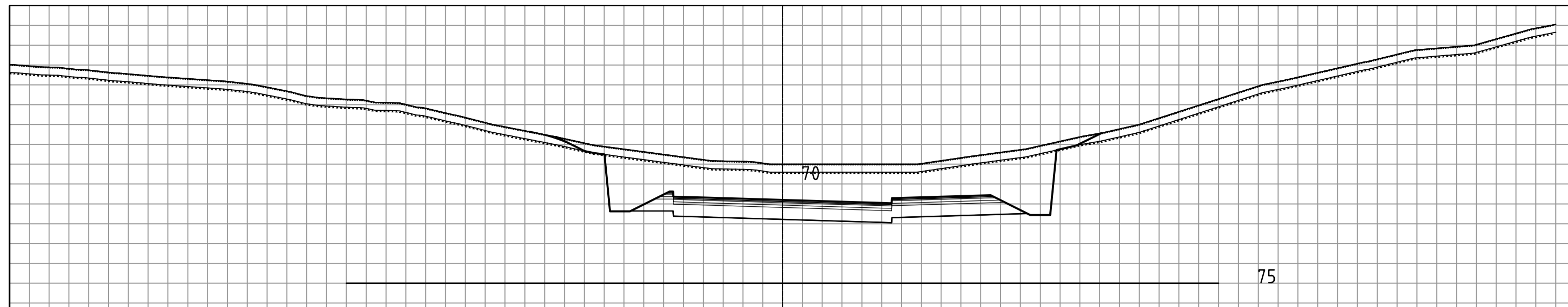

OPUS

Lonena aust (46312021003)
PLANFLATE 1
Interne vegar

Tverrprofil Veg 2

Stad:	Bergen	Prosj.nr.	21000	Teikn.nr.	U110	Rev.	-
Dato:	10.06.22						
Målestokk:	1:100(A1)						
Pros.ansv.:	HH						
Teikna av:	TV						
Kontrollert av:	EB						

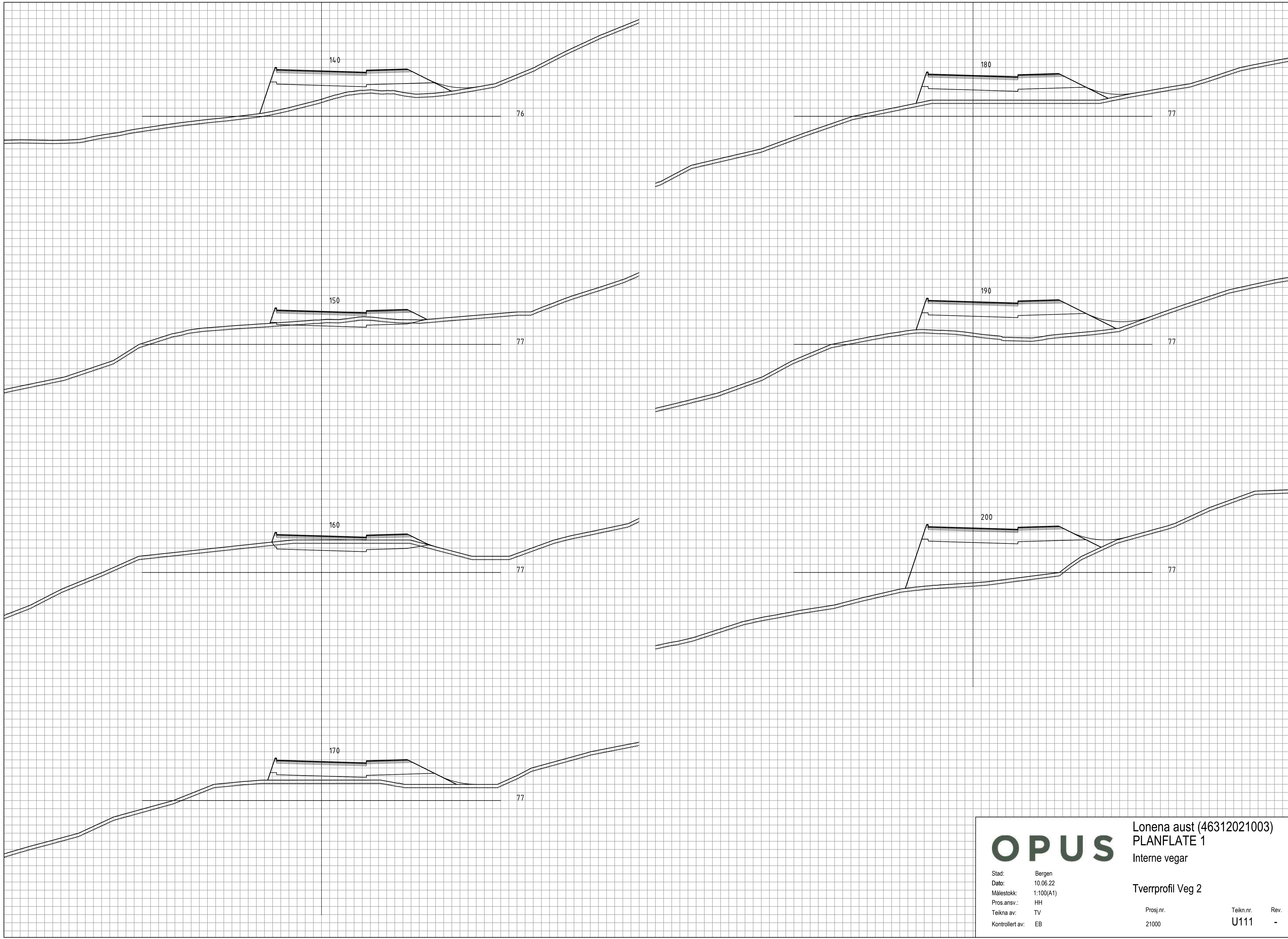

OPUS

Stad: Bergen
 Dato: 10.06.22
 Målestokk: 1:100(A1)
 Pros.anstv.: HH
 Teikna av: TV
 Kontrollert av: EB

Lonena aust (46312021003)
 PLANFLATE 1
 Interne vegar

Tverrprofil Veg 2

Prosj.nr.
 21000

Teikn.nr. Rev.
 U111 -

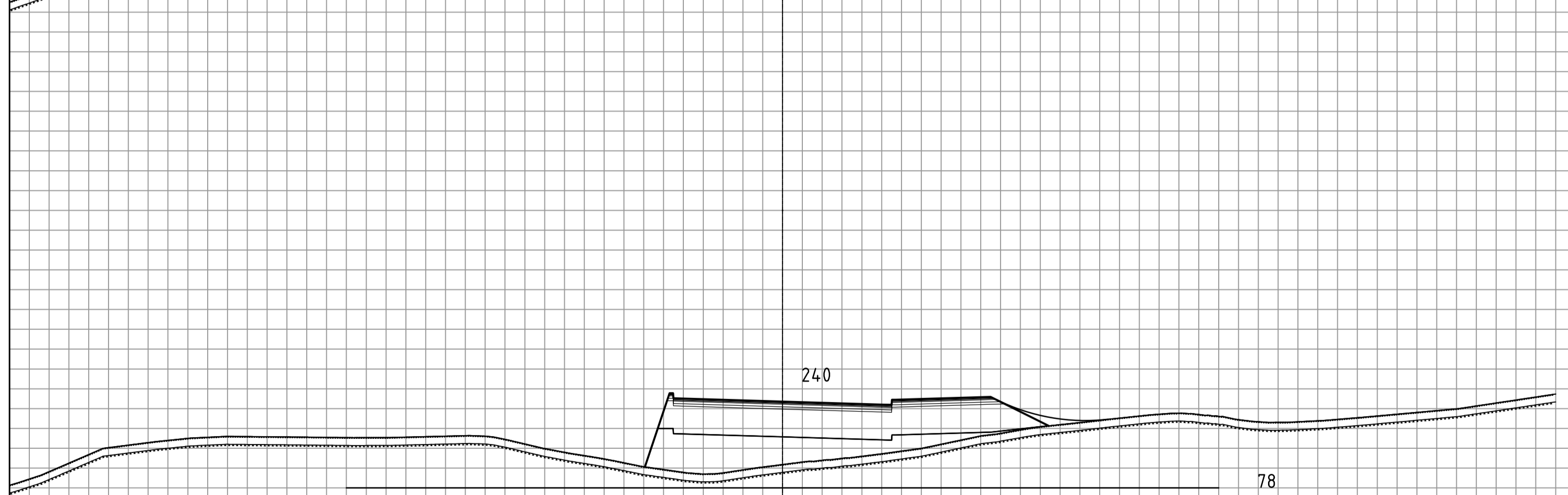
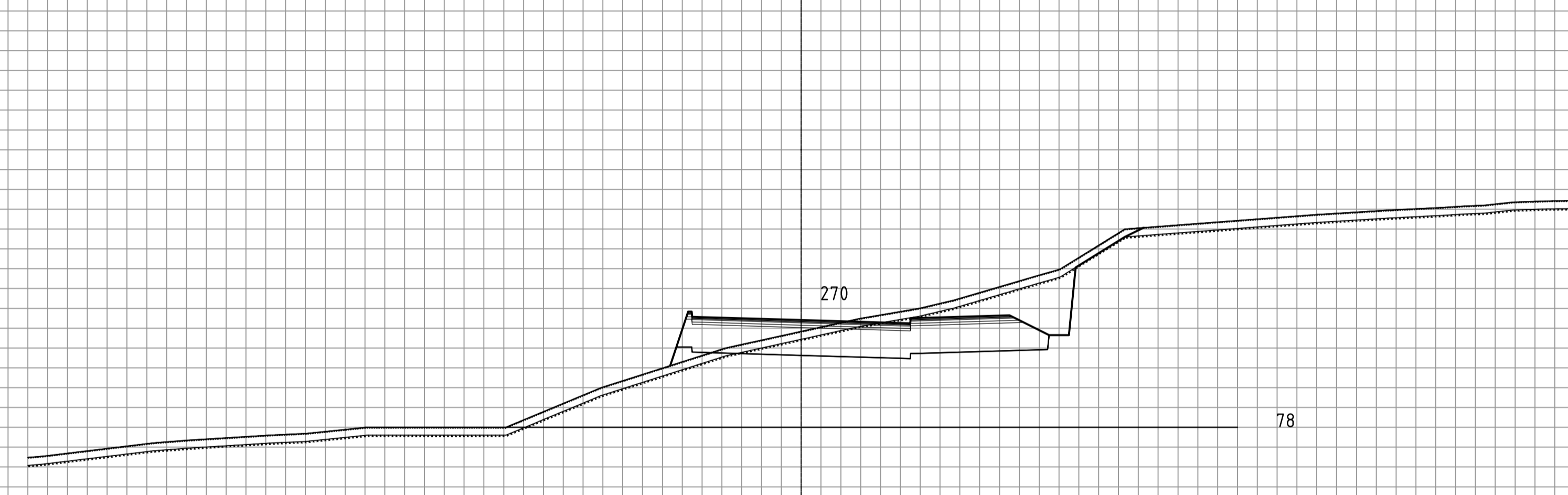
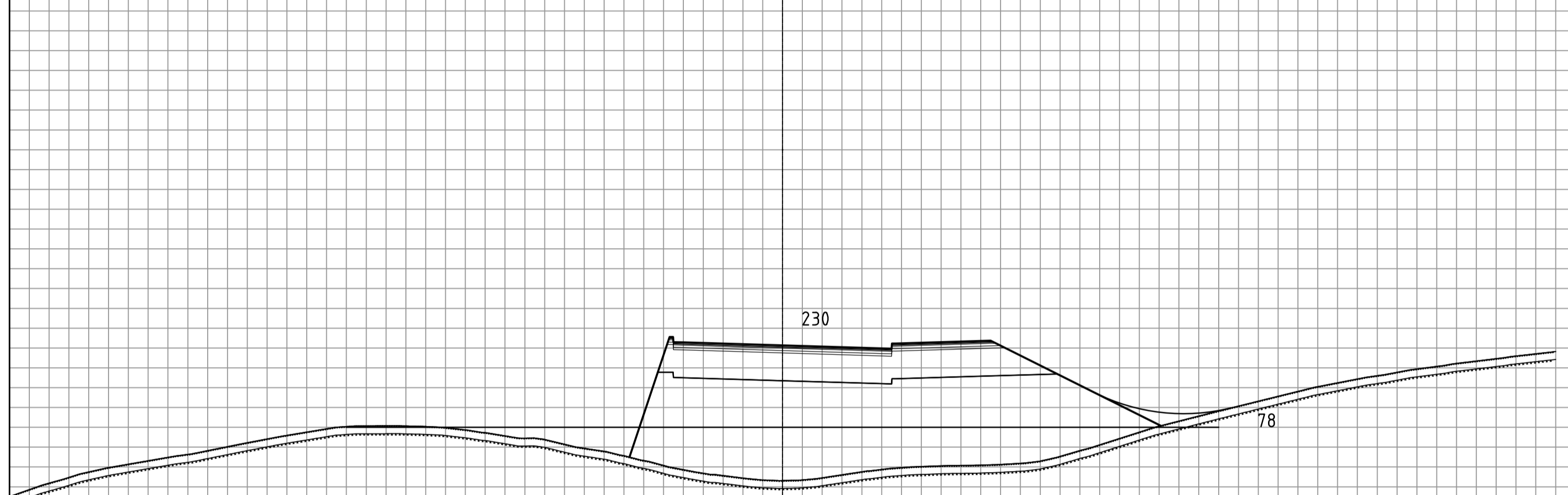
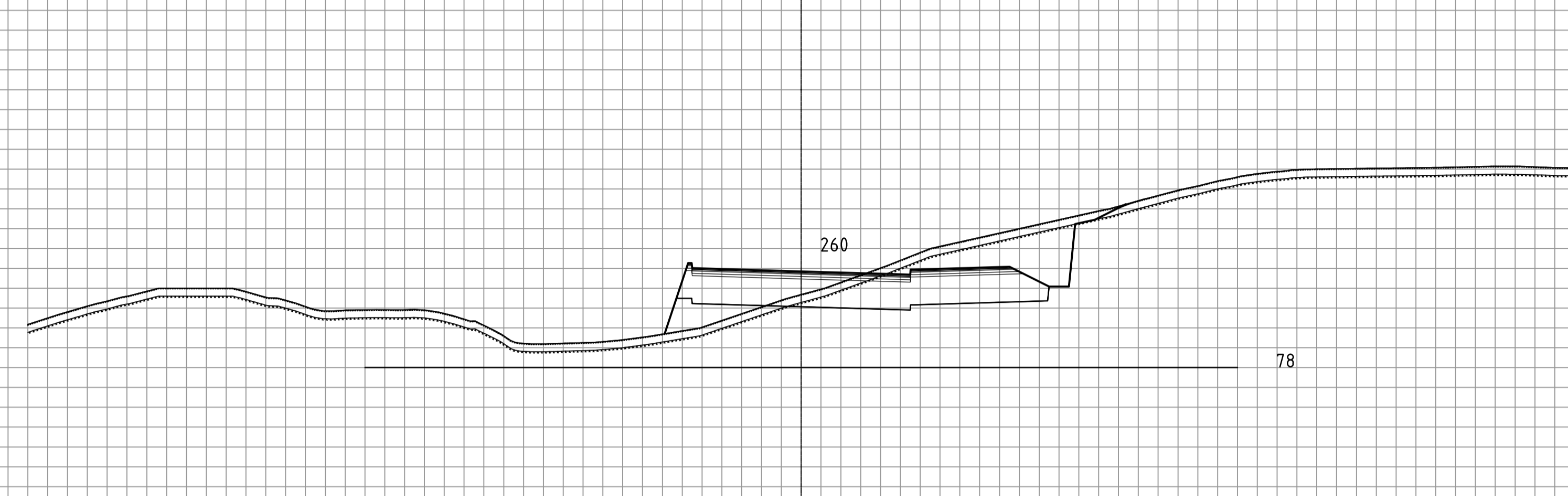
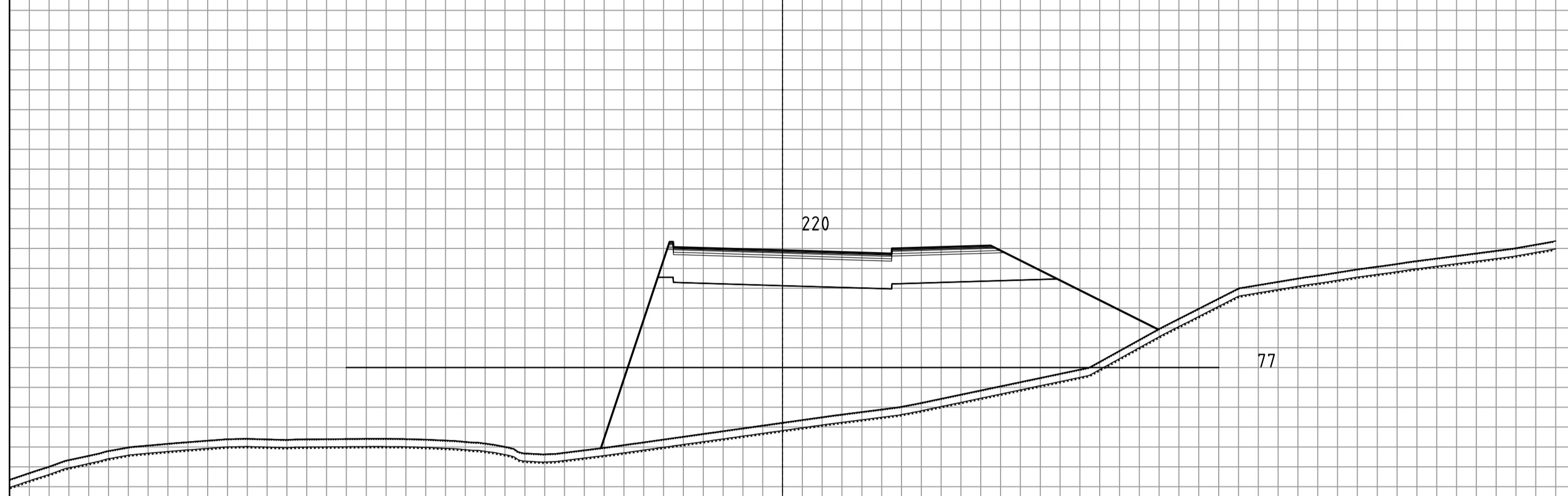
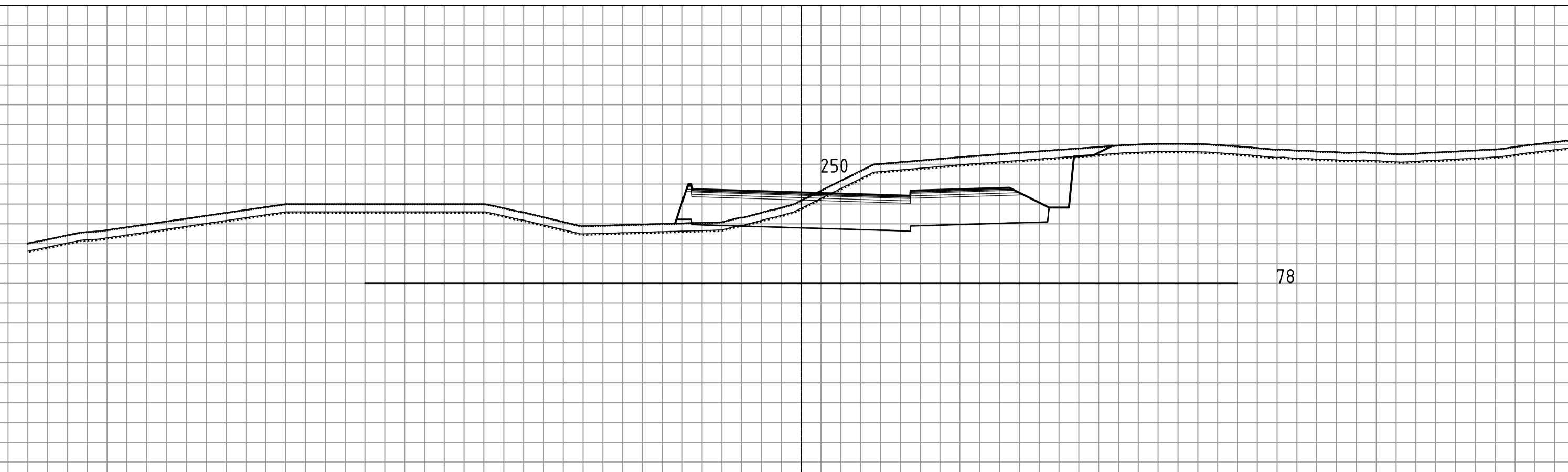
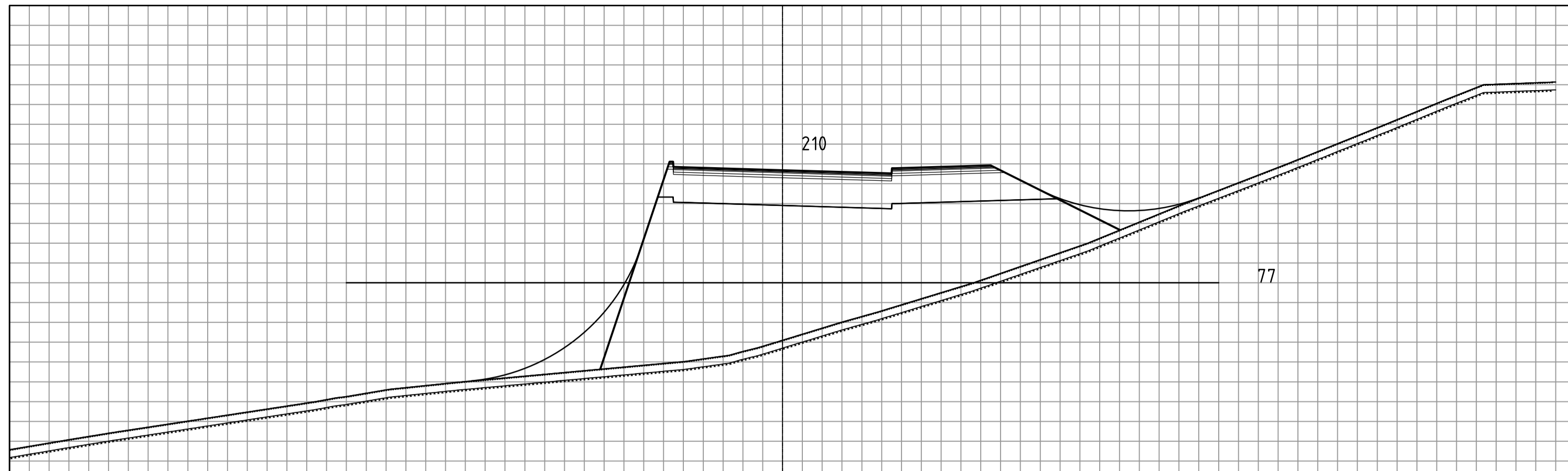

OPUS

Stad: Bergen
 Dato: 10.06.22
 Målestokk: 1:100(A1)
 Pros.ansv.: HH
 Teikna av: TV
 Kontrollert av: EB

Lonena aust (46312021003)
 PLANFLATE 1
 Interne vegar

Tverrprofil Veg 2

Prosj.nr.	Teikn.nr.	Rev.
21000	U112	-

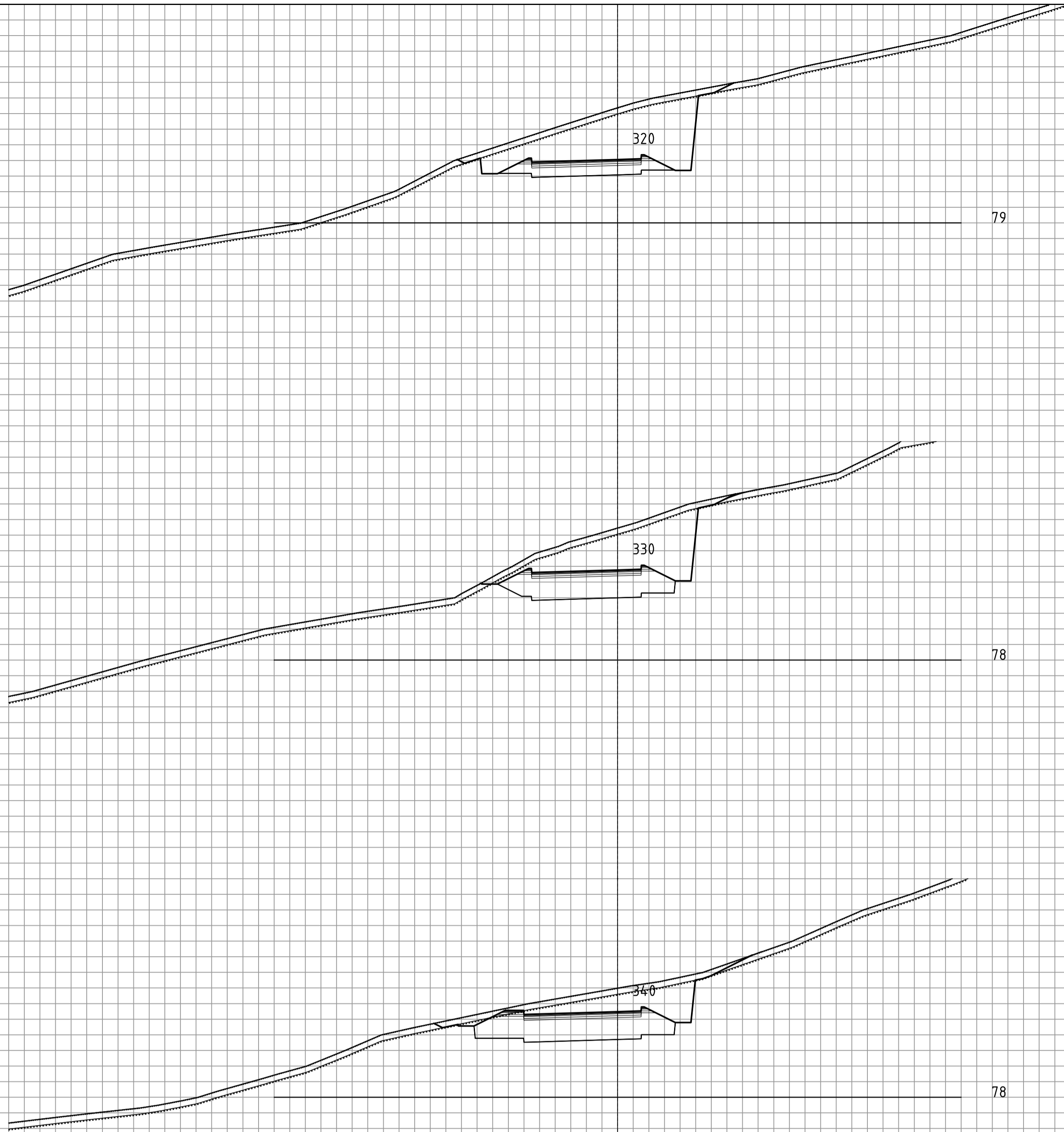

OPUS

Lonena aust (46312021003)
 PLANFLATE 1
 Interne vegar

Stad: Bergen
 Dato: 10.06.22
 Målestokk: 1:100(A1)
 Pros.ansv.: HH
 Teikna av: TV
 Kontrollert av: EB

Tverrprofil Veg 2

Prosj.nr.
 21000

Teikn.nr. Rev.
 U113 -

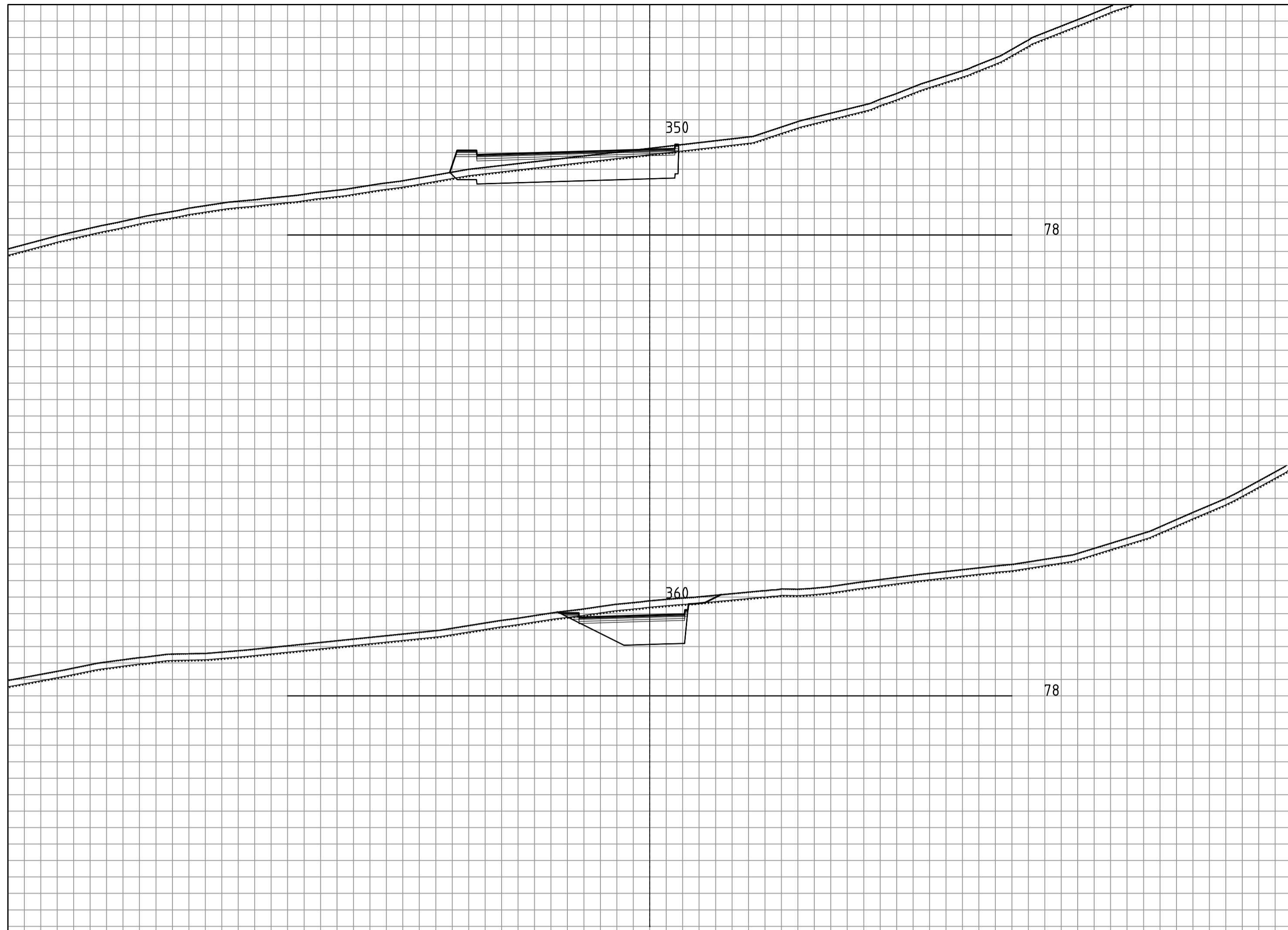

OPUS

Lonena aust (46312021003)
PLANFLATE 1
Interne vegar

Stad: Bergen
Dato: 10.06.22
Målestokk: 1:100(A1)
Pros.ansv.: HH
Teikna av: TV
Kontrollert av: EB

Tverrprofil Veg 2

Prosj.nr.
21000

Teikn.nr. Rev.
U114 -

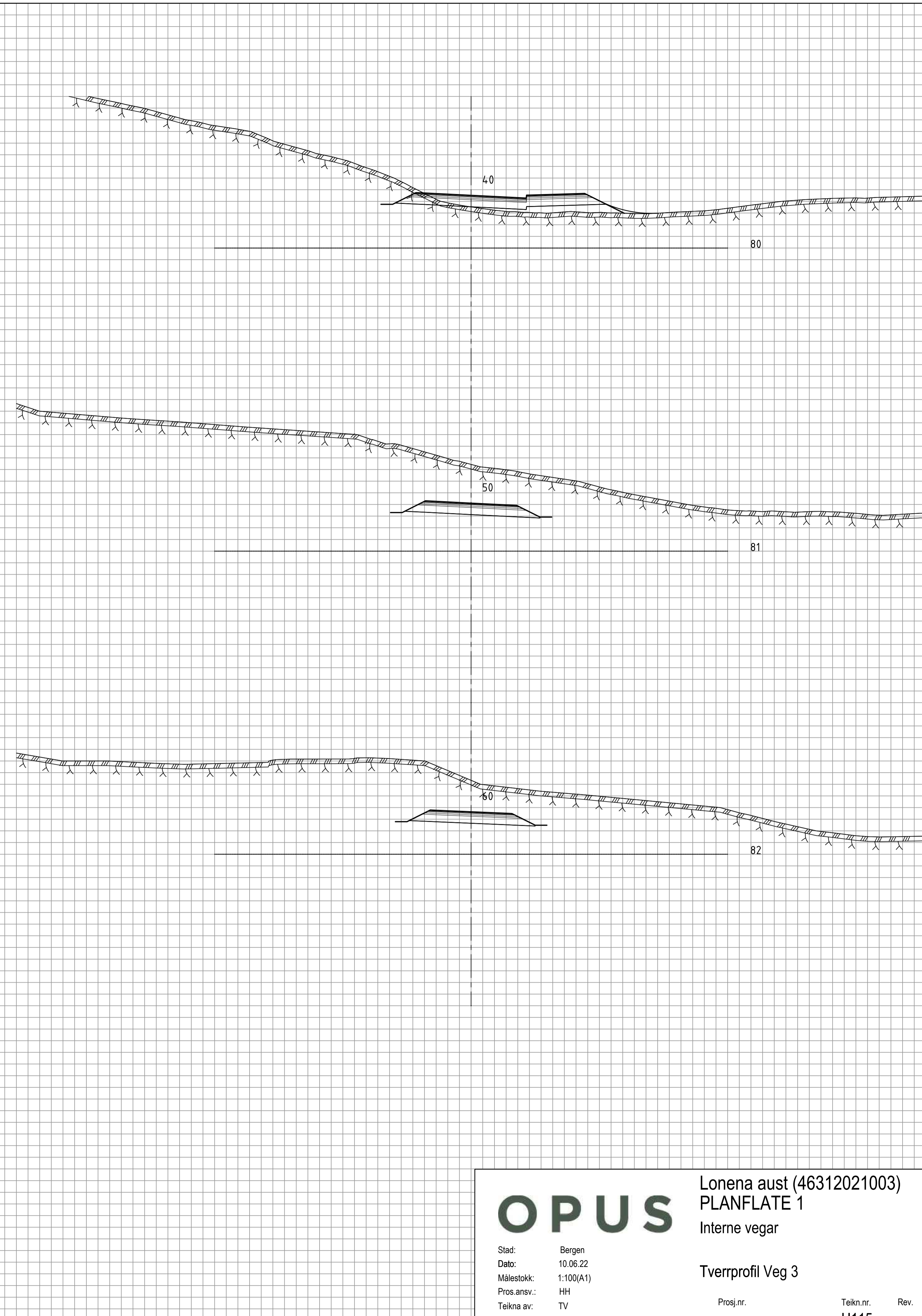
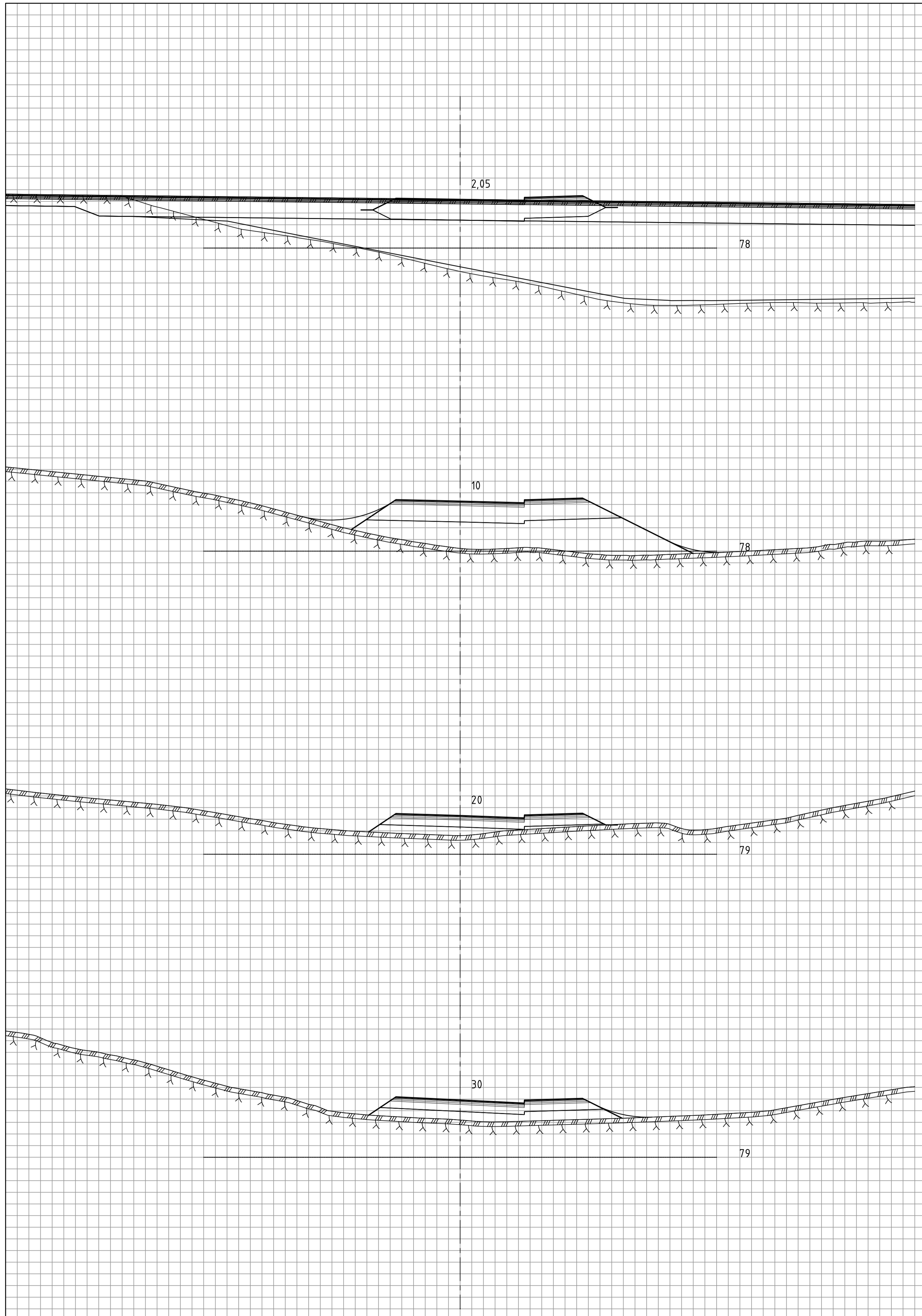

OPUS		Lonena aust (46312021003)	
		PLANFLATE 1	
		Interne vegar	
		Tverrprofil Veg 3	
Stad:	Bergen	Prosj.nr.	Teikn.nr.
Dato:	10.06.22	21000	U115
Målestokk:	1:100(A1)		Rev.
Pros.ansv.:	HH		-
Teikna av:	TV		
Kontrollert av:	EB		

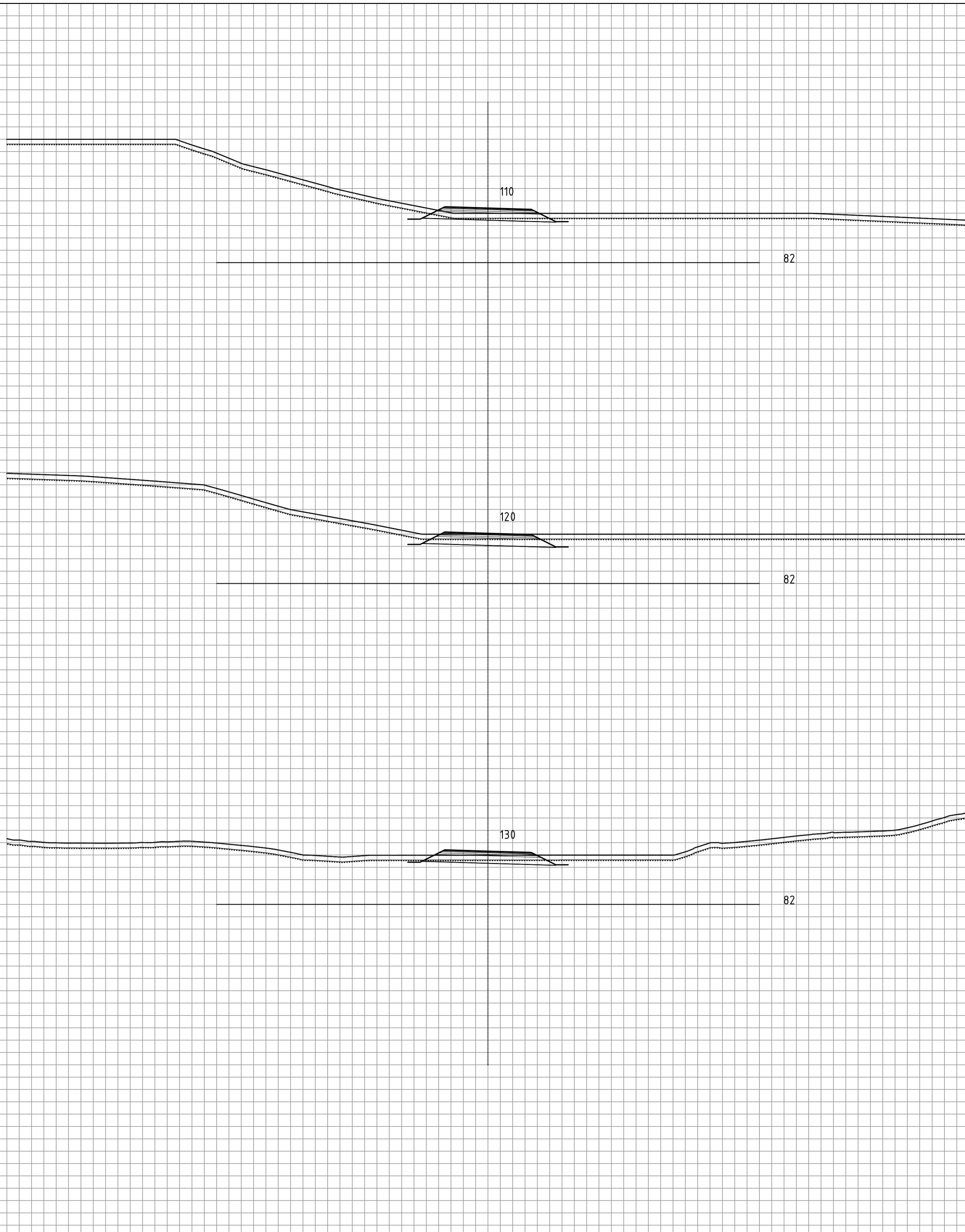
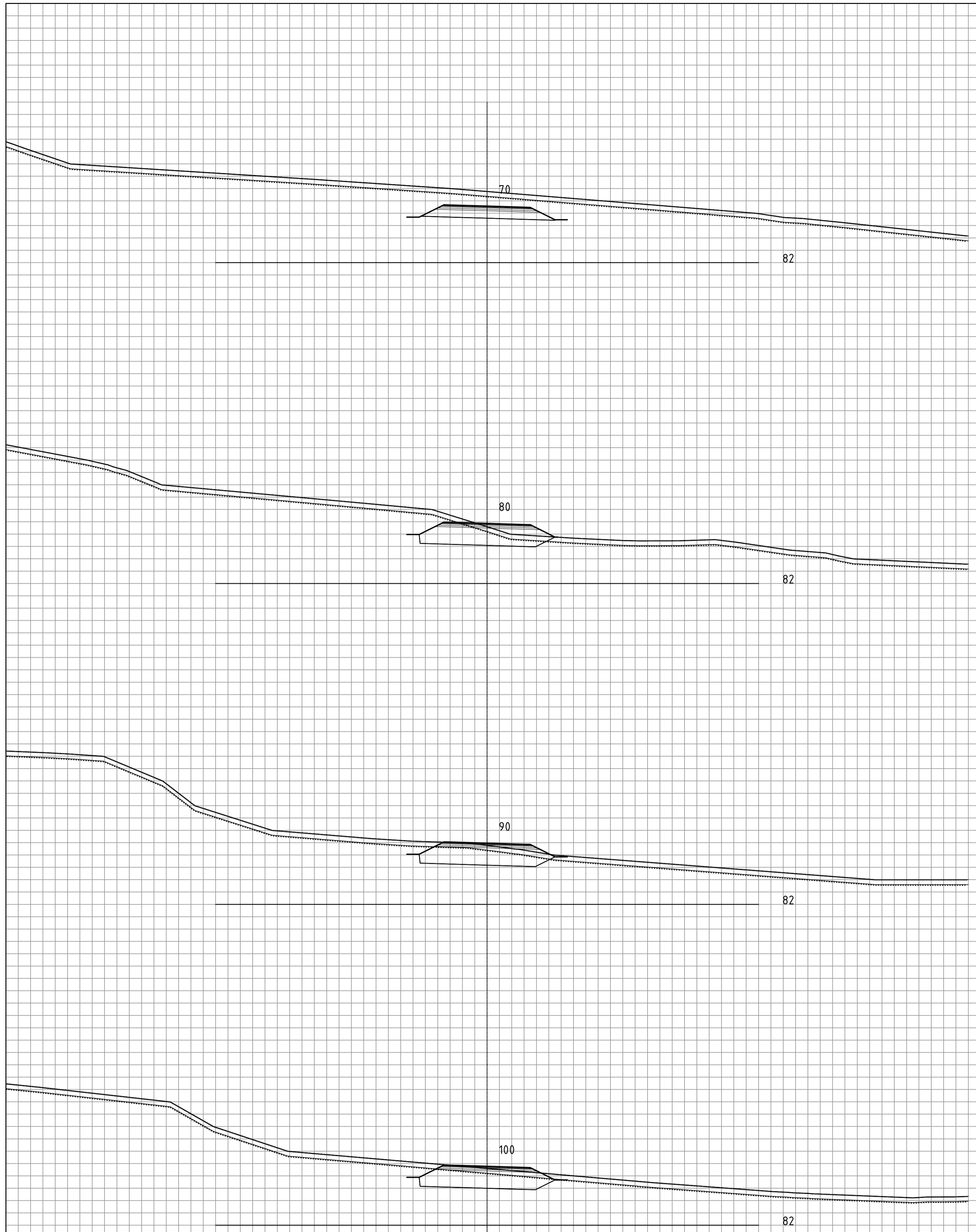

OPUS		Lonena aust (46312021003)	
		PLANFLATE 1	
		Interne vegar	
		Tverrprofil Veg 3	
Stad:	Bergen	Prosj.nr.	Teikn.nr.
Dato:	10.06.22	21000	U116
Målestokk:	1:100(A1)		
Pros.ansv.:	HH		
Teikna av:	TV		
Kontrollert av:	EB		

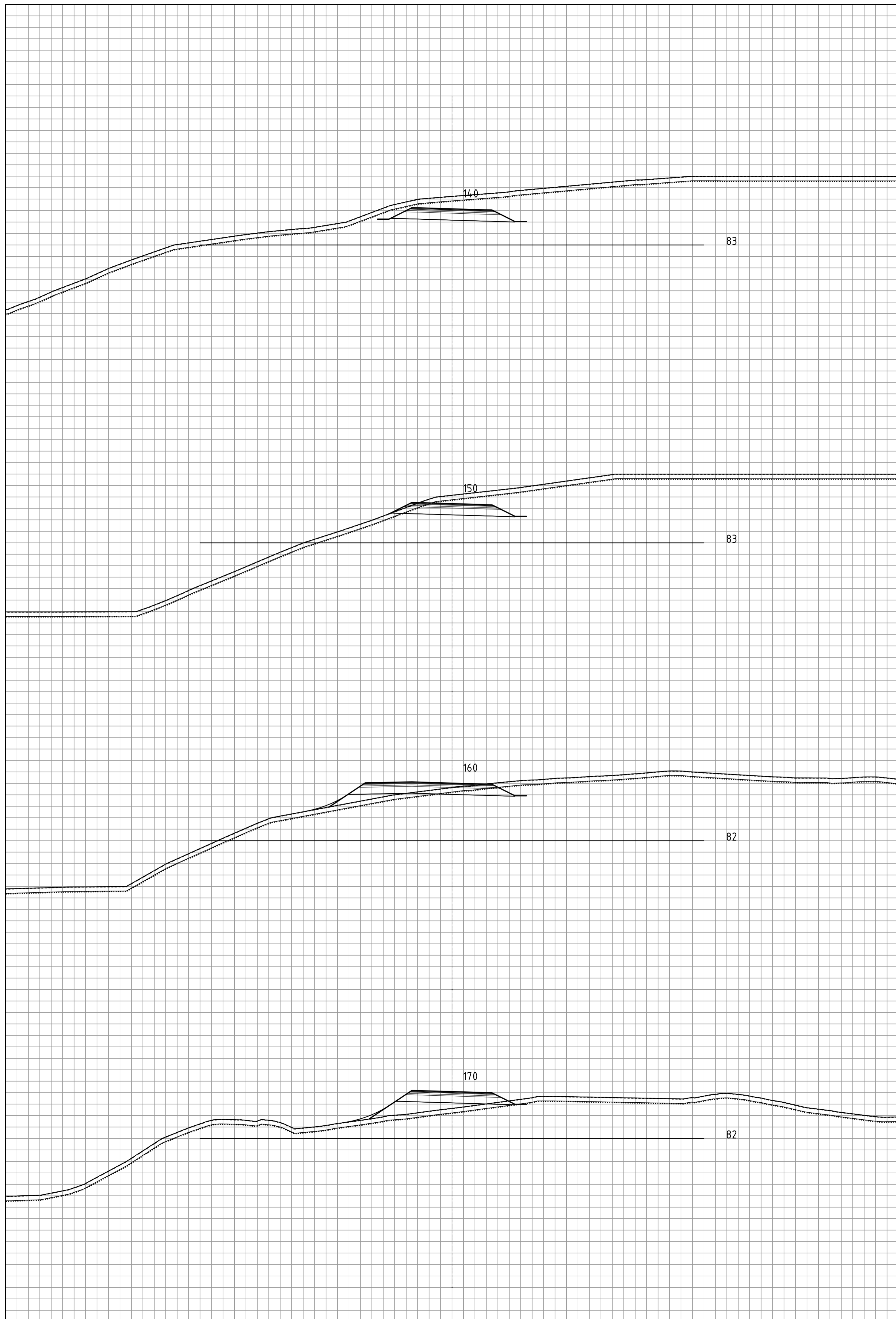

OPUS		Lonena aust (46312021003)	
		PLANFLATE 1	
		Interne vegar	
		Tverrprofil Veg 3	
Stad:	Bergen	Prosj.nr.	Teikn.nr.
Dato:	10.06.22	21000	U117
Målestokk:	1:100(A1)		
Prosj.ansv.:	HH		
Teikna av:	TV		
Kontrollert av:	EB		

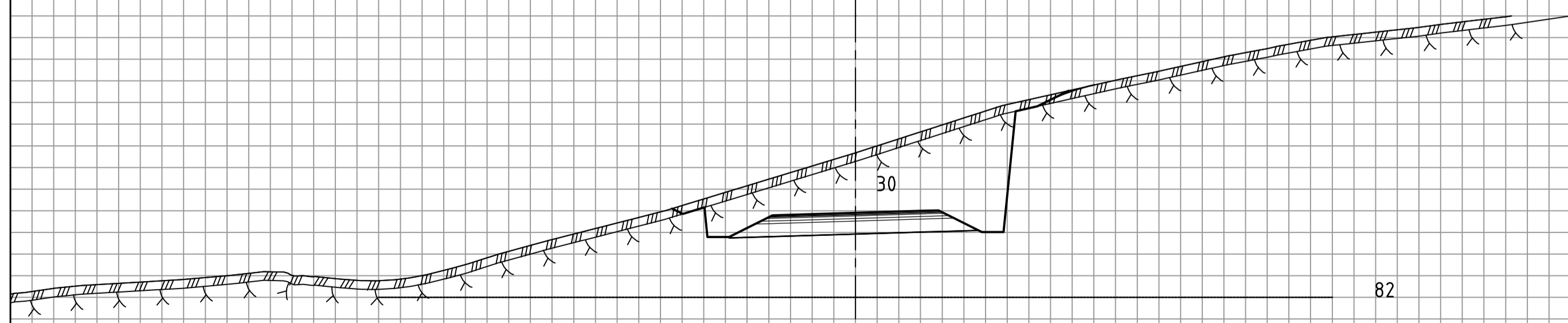
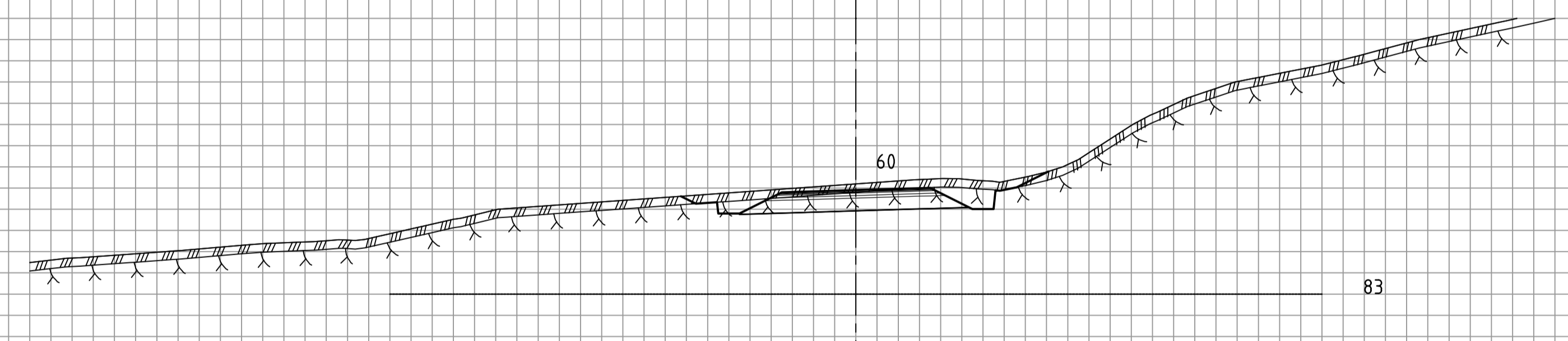
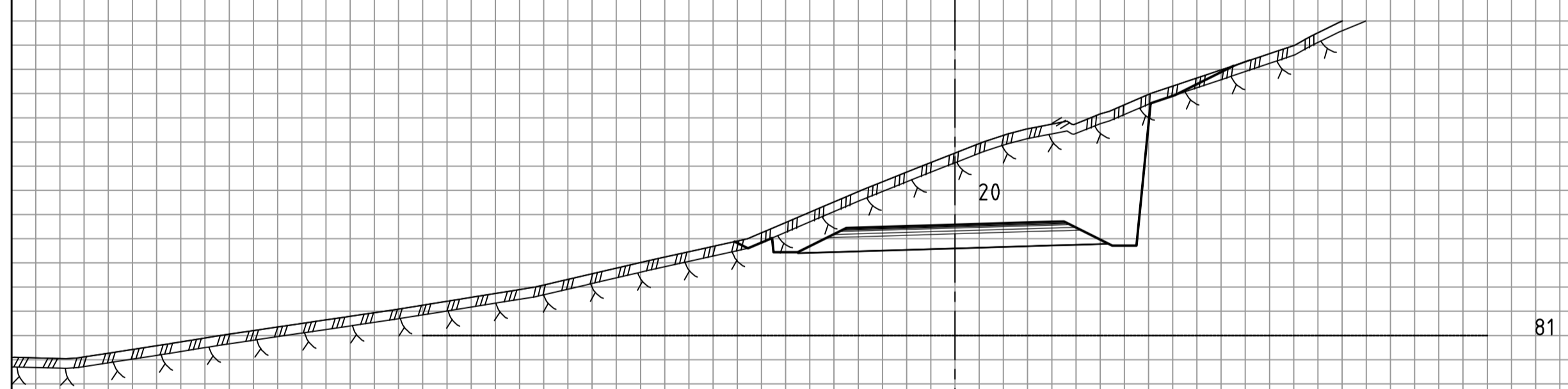
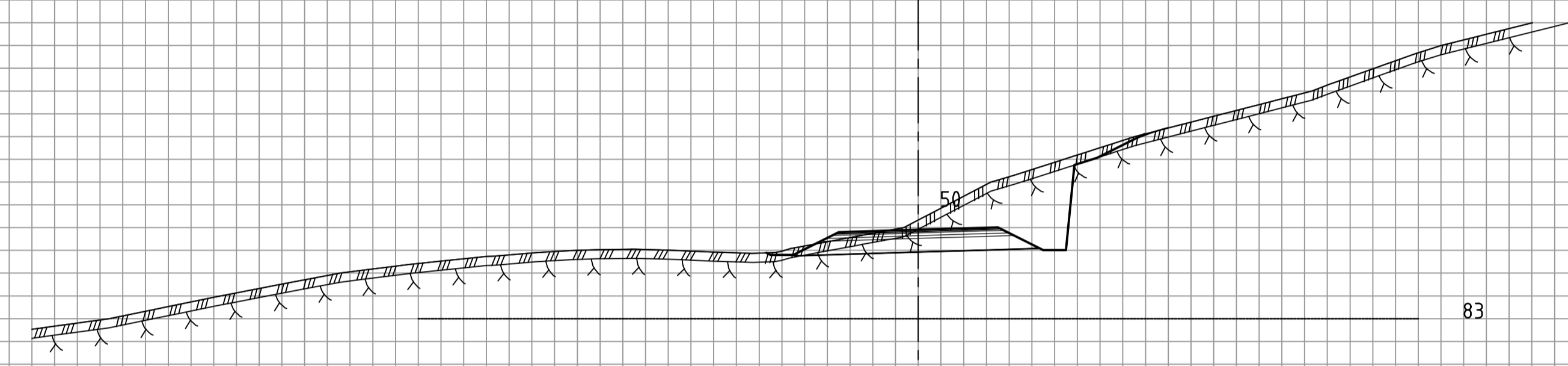
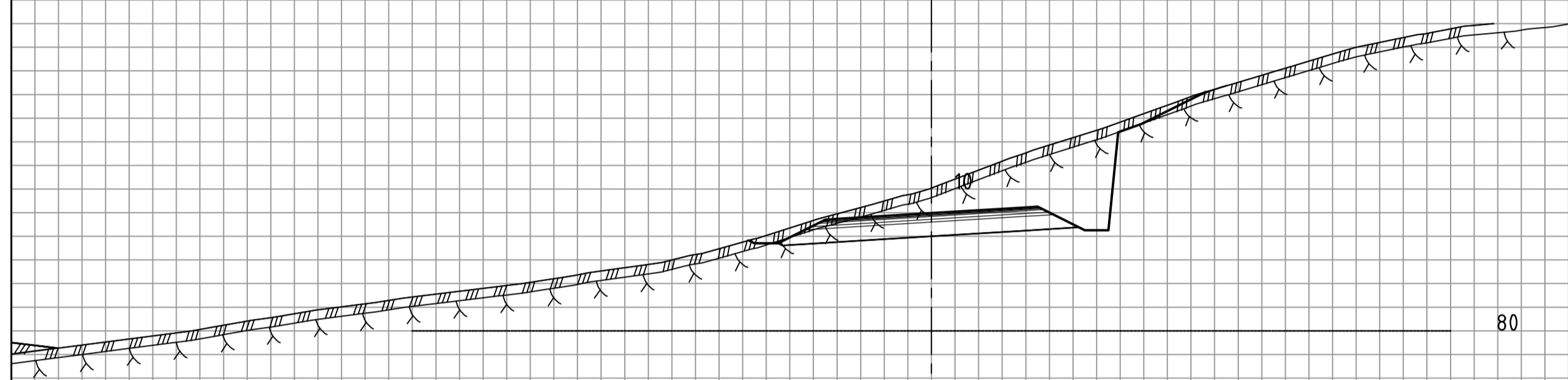
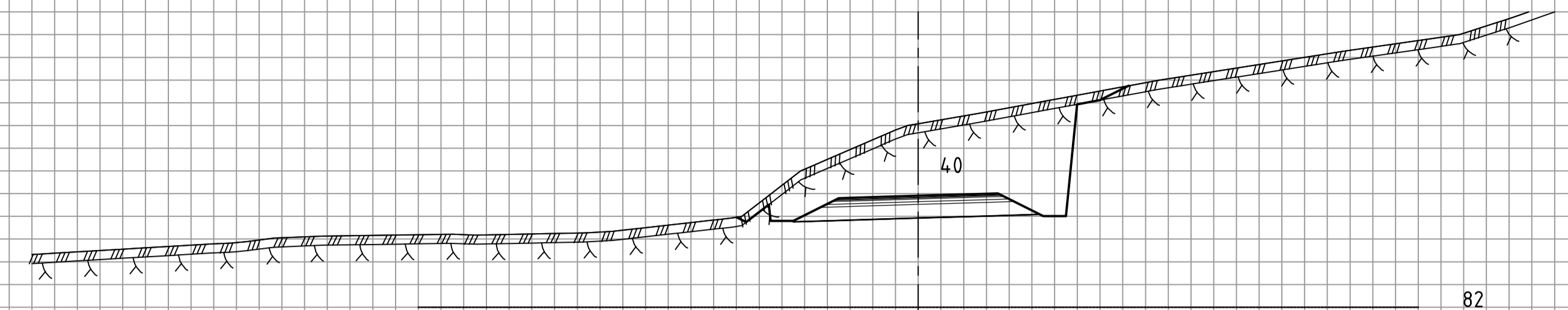
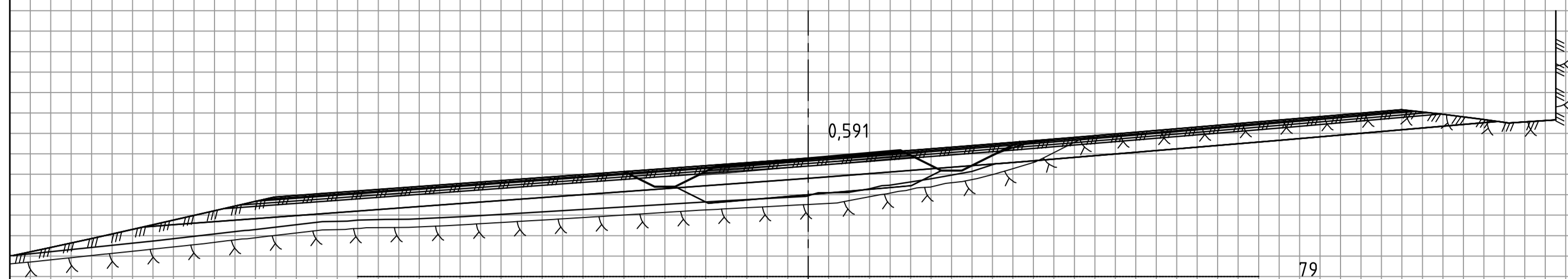

OPUS

Lonena aust (46312021003)
 PLANFLATE 1
 Interne vegar

Tverrprofil Veg 4

Stad:	Bergen	Prosj.nr.	21000	Teikn.nr.	U118	Rev.	-
Dato:	10.06.22						
Målestokk:	1:100(A1)						
Pros.ansv.:	HH						
Teikna av:	TV						
Kontrollert av:	EB						

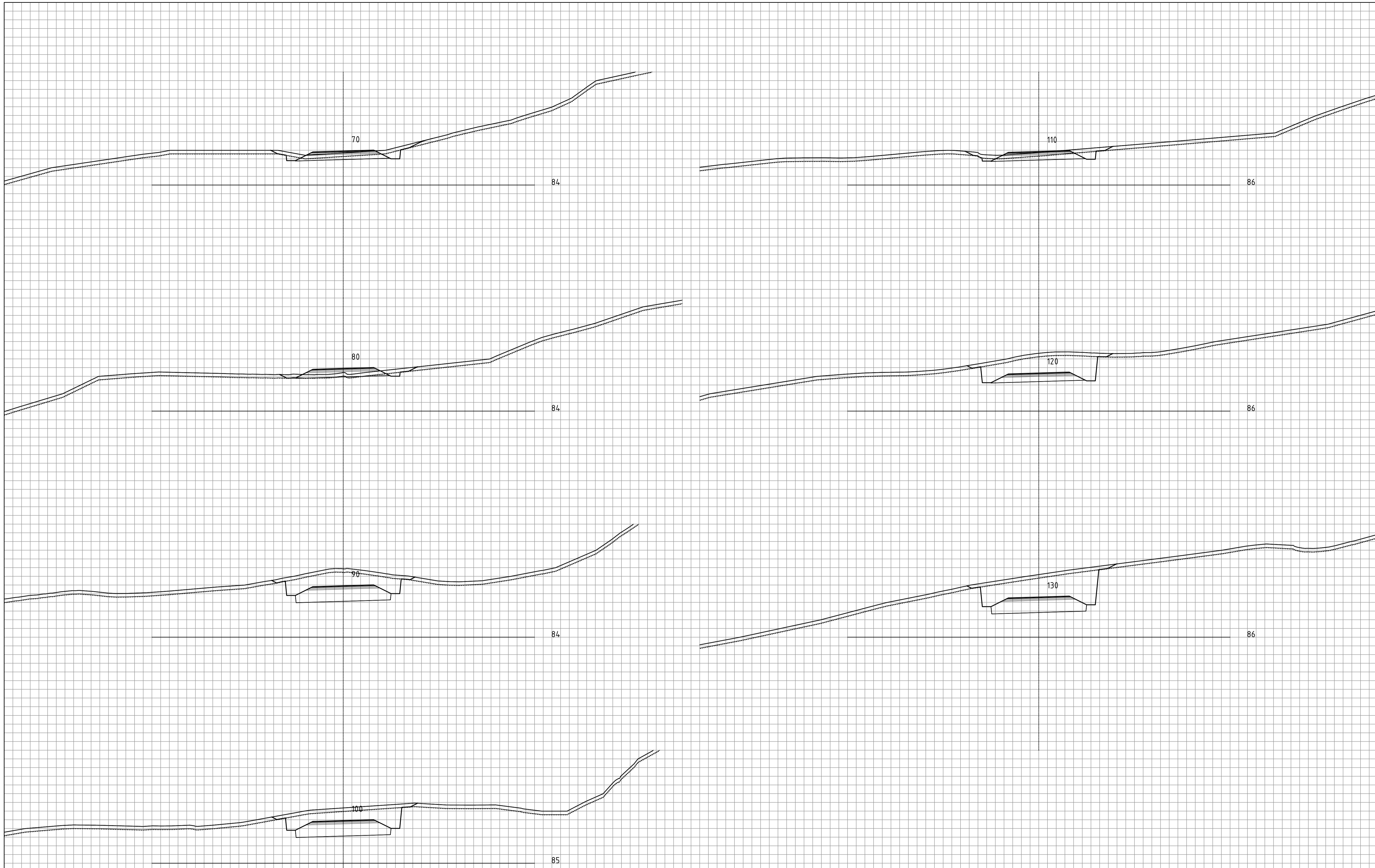

OPUS		Lonena aust (46312021003)	
		PLANFLATE 1	
		Interne vegar	
		Tverrprofil Veg 4	
Stad:	Bergen	Prosj.nr.	Teikn.nr.
Dato:	10.06.22	21000	U119
Målestokk:	1:100(A1)		
Pros.ansv.:	HH		
Teikna av:	TV		
Kontrollert av:	EB		

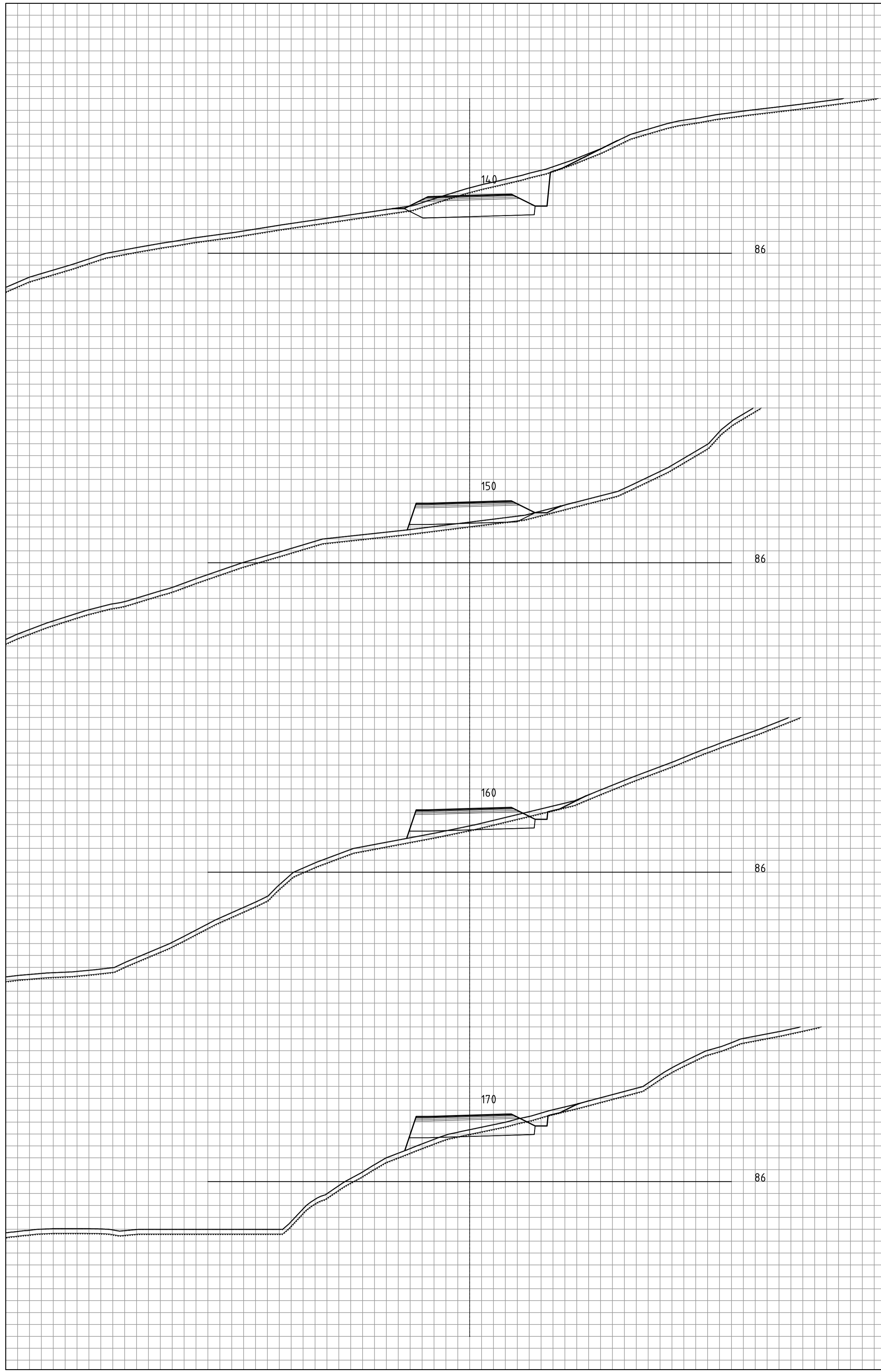

OPUS

Lonena aust (46312021003)
 PLANFLATE 1
 Interne vegar

Stad: Bergen
 Dato: 10.06.22
 Målestokk: 1:100(A1)
 Pros.ansv.: HH
 Teikna av: TV
 Kontrollert av: EB

Tverrprofil Veg 4

Prosj.nr.
 21000

Teikn.nr. Rev.
 U120 -