

2  
A101

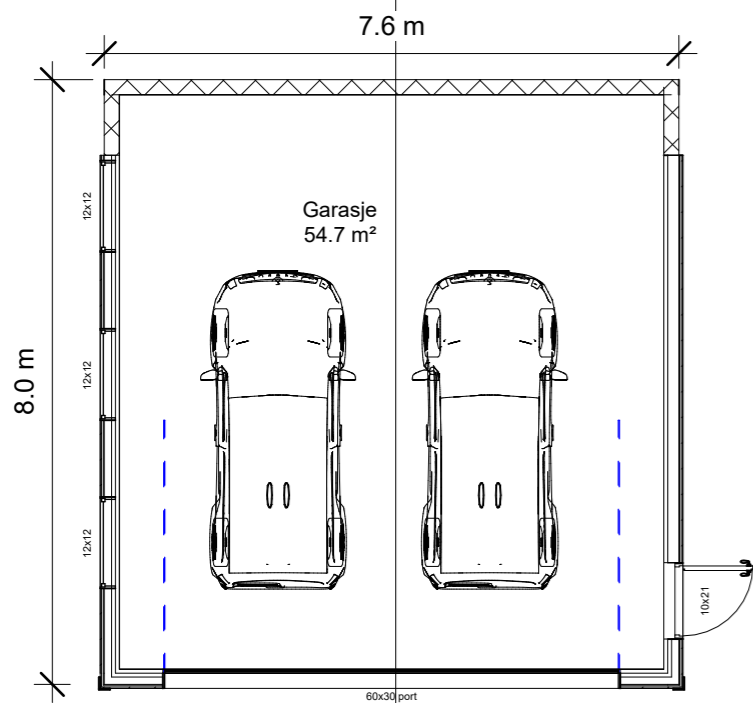

**Level 1**

1 : 100

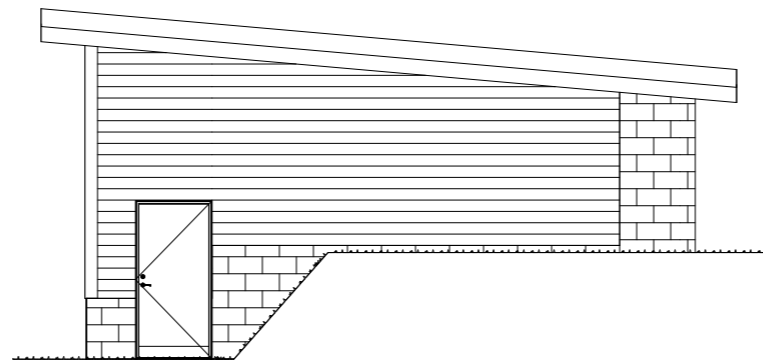

**East**

1 : 100

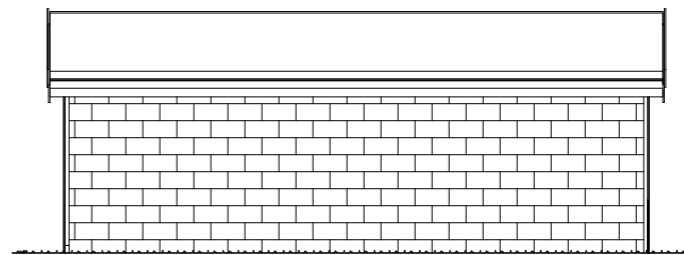

**North**

1 : 100

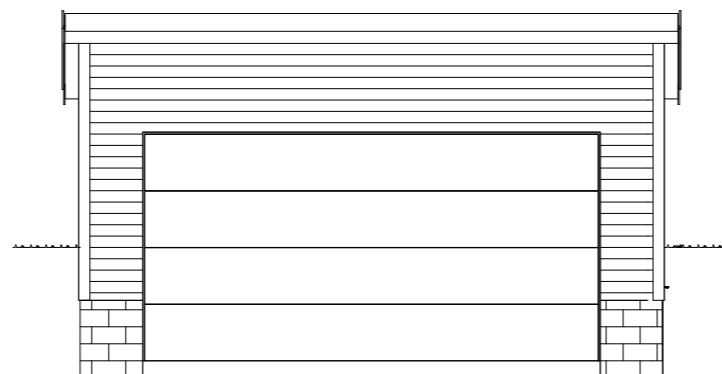

**South**

1 : 100

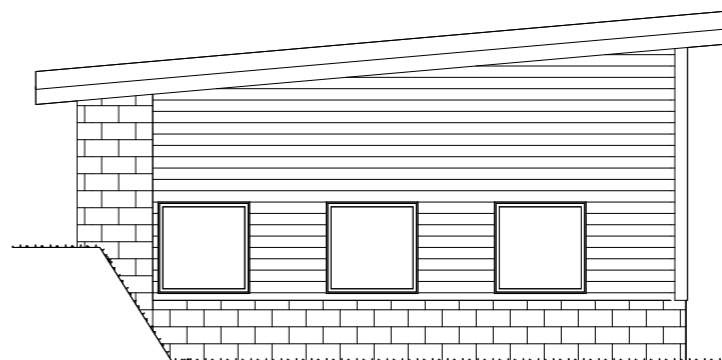

**West**

1 : 100

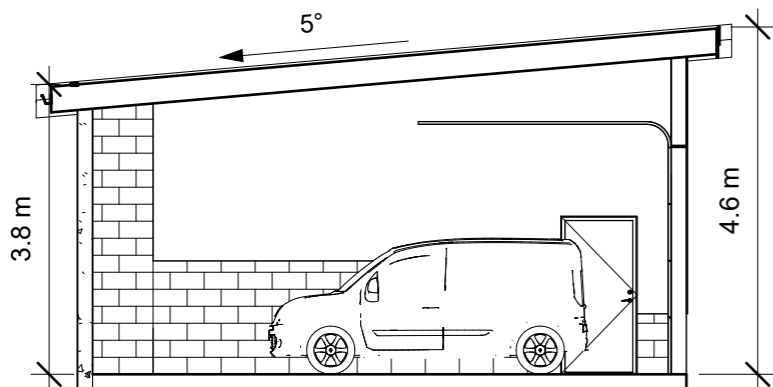

**Section 1**

1 : 100

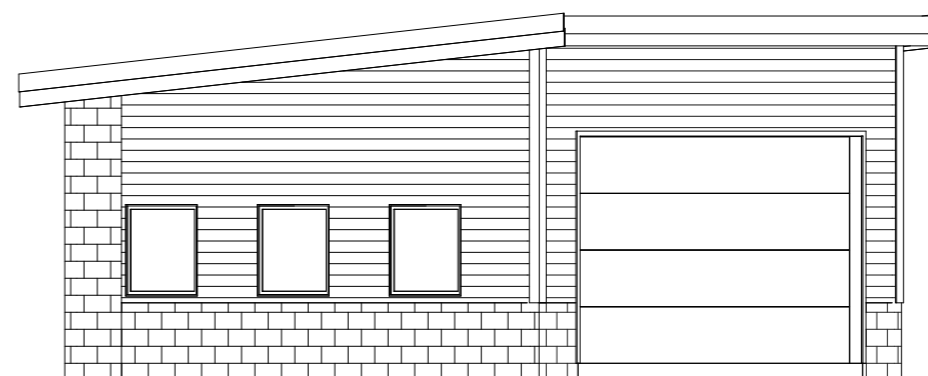

7 {3D}

**Areal tabell**

Etasje	Type	Areal
1.etg	Primær areal	54,7

**Sum BRA** 54,7m<sup>2</sup>

**BYA** 61,9m<sup>2</sup>

**Merknad**

1

2

3

4

5

6

7

Tiltakshaver	Petter Brakstad	<b>plan, snitt, fasade</b>			
Prosjekt	Garasje				
Byggeplass/Adresse	VESTBYGDVEGEN 8 5919 FREKHAUG	G/bnr 305/123 Alver Kommune	Dato	12.05.23	<b>A101</b>
		Byggemeldingstegninger	Revisjon	13.06.2023	
			Tegn av	Rune.K	
			Kontroll	Checker	