

Forslag til garasjeplasseringer
 Gnr. 10 , Bnr. 255 i Meland kommune
 Sit.kart i Mål = 1 : 250
 Frekhaug , 03.03.2017

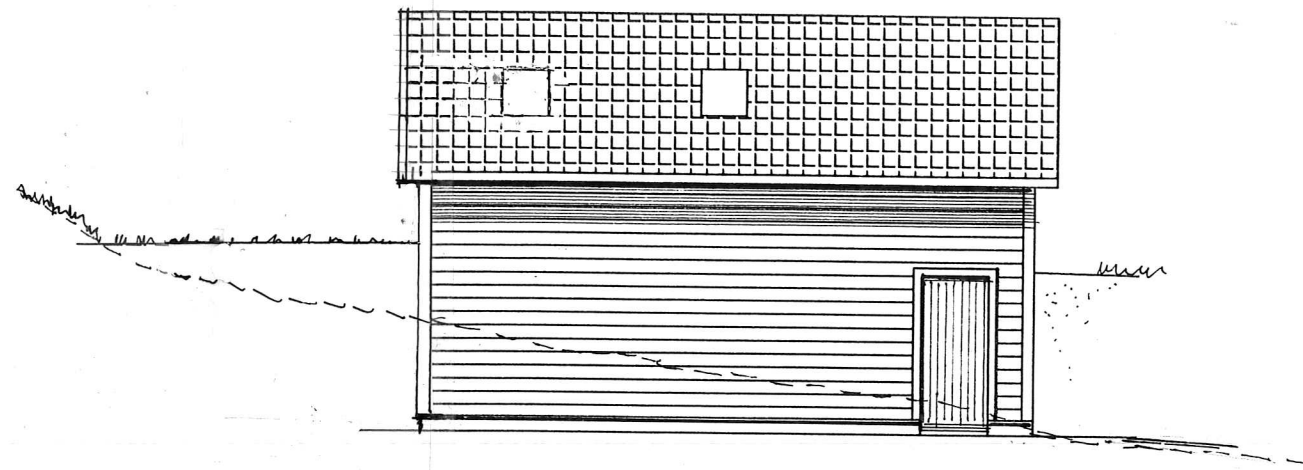

Byggteam Vest AS



Fasade mot ØST

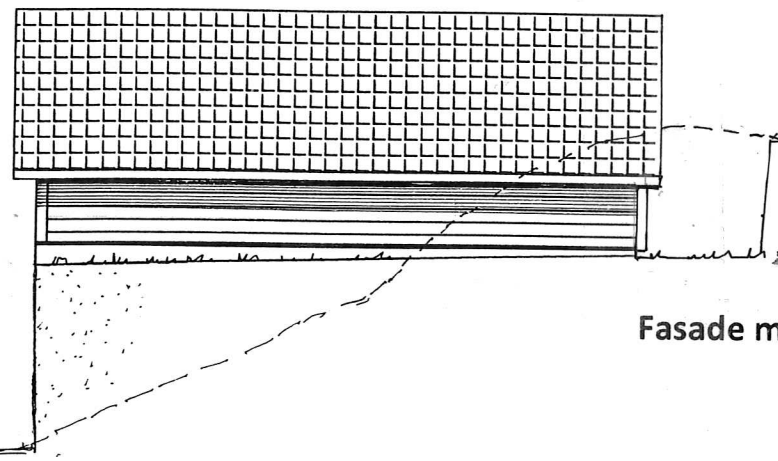

Fasade mot VEST

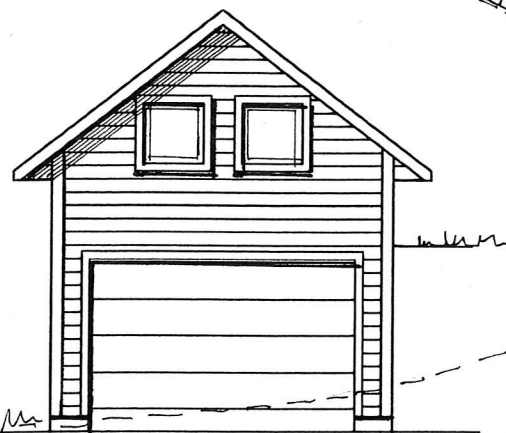

Fasadfe mot NORD

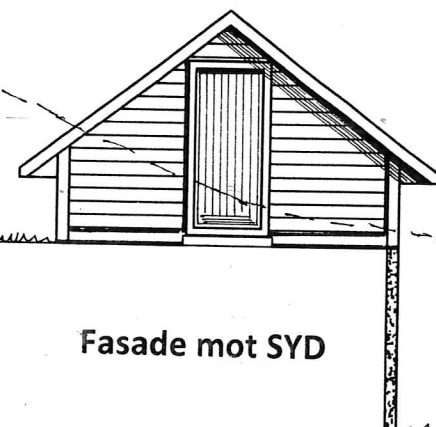

Fasade mot SYD

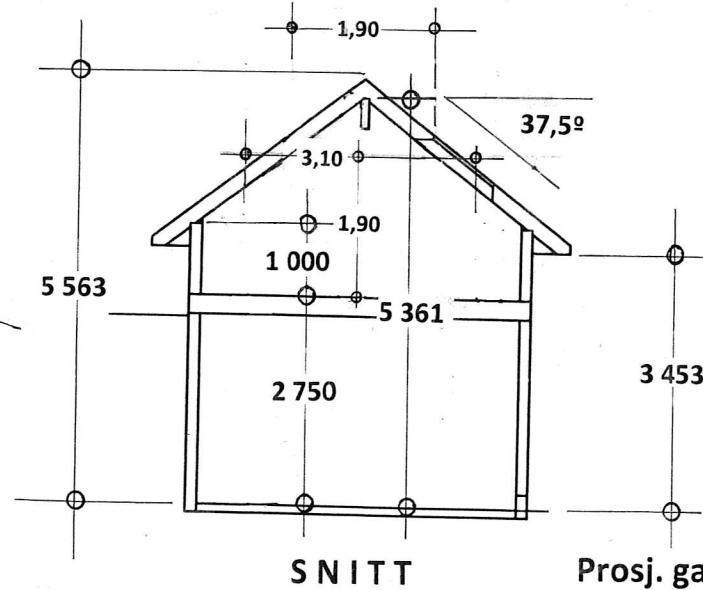
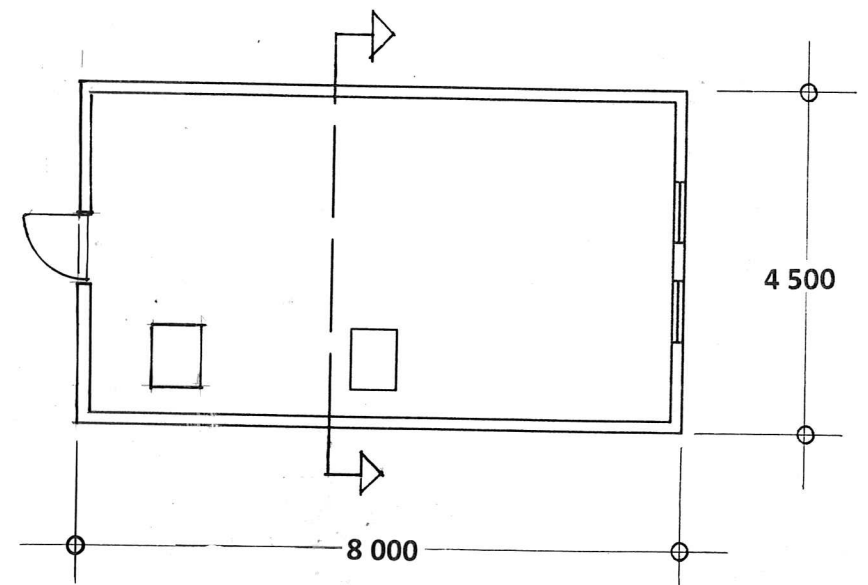
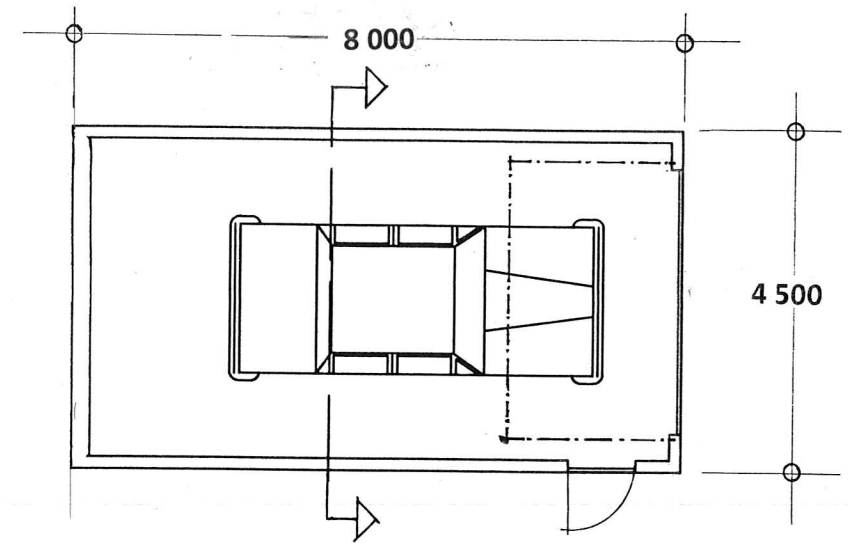

SNITT

BYA 36 m²

BTA 36 m²

BRA 58 m²

Prosj. garasje på Gnr. 10 , Bnr. 255 i Meland kommune

Plan , Snitt – og Fasader i Mål = 1 : 100

Isdalstø , 31. 08. 2016

Rettet : 02.02.2017

Rettet : 01.06.2017



Byggteam Vest AS