

SITUASJONSKART

Gnr/Bnr: 10/255
 Adresse: Holmeknappen
 Eigar/søkar: Cato/ Hege-Iren Rasmussen/ E- Tangen
 Kvalitet : FKB-B



MELAND
KOMMUNE



Målestokk: 1:500
 Dato: 27.04.2016

Gjeldande plan : Kommuneplan
 Planformål : LNF7 100-m beltet frå sjø
 Vår referanse: Amg

- Gjerde
- Usikker eigedomsgrense
- Målt eigedomsgrense
- Bolighus
- Andre bygg

Sign.

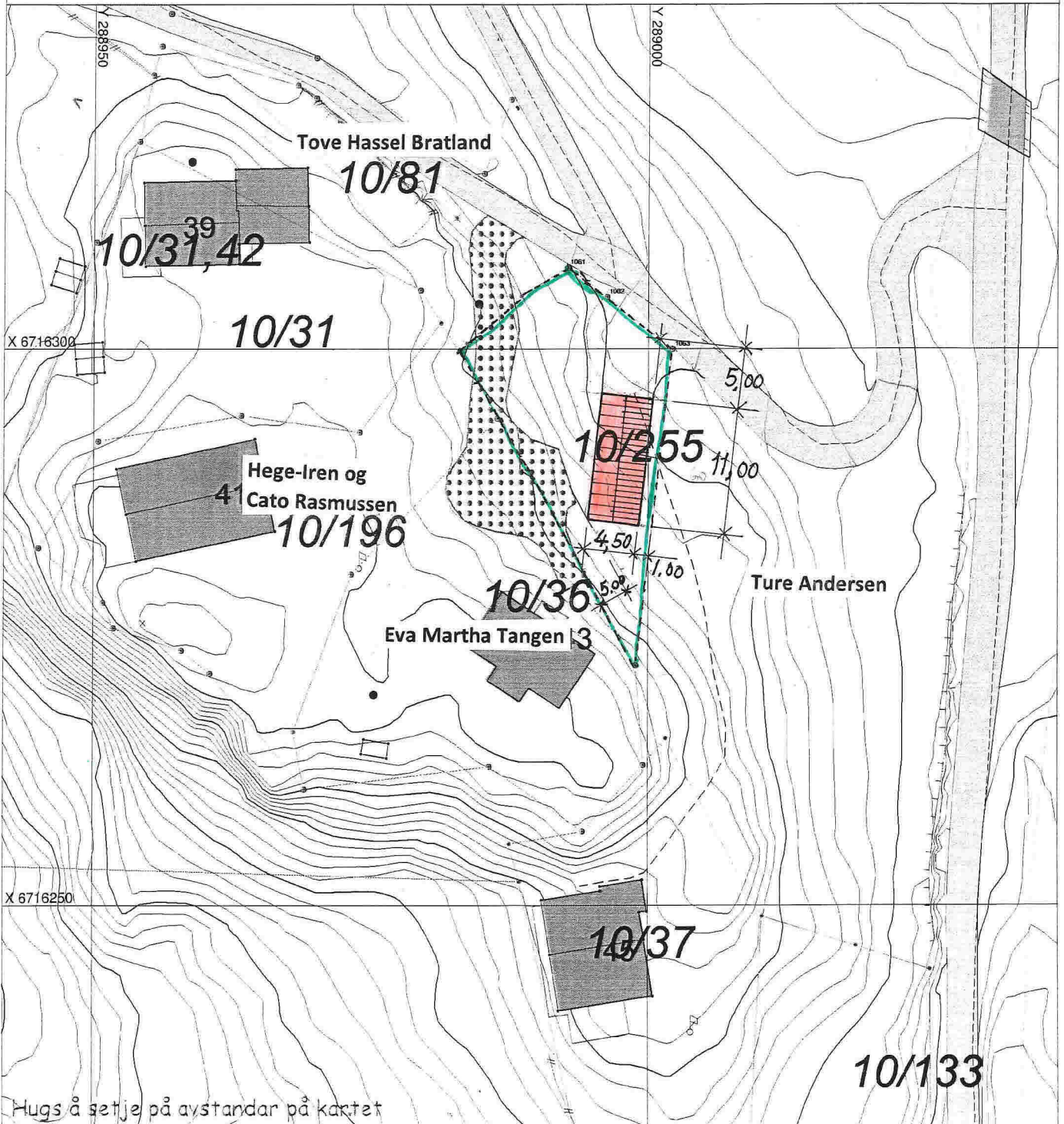

Hugs å setje på avstandar på kartet

SITUASJONSPLAN

Tiltak

Underskrift Situasjonsplan _____ Dato _____

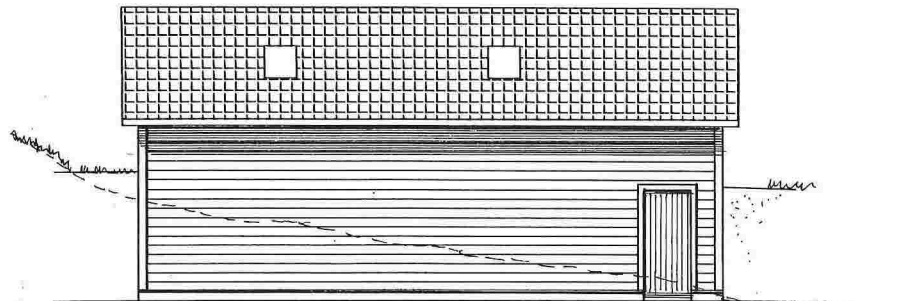

Fasade mot ØST

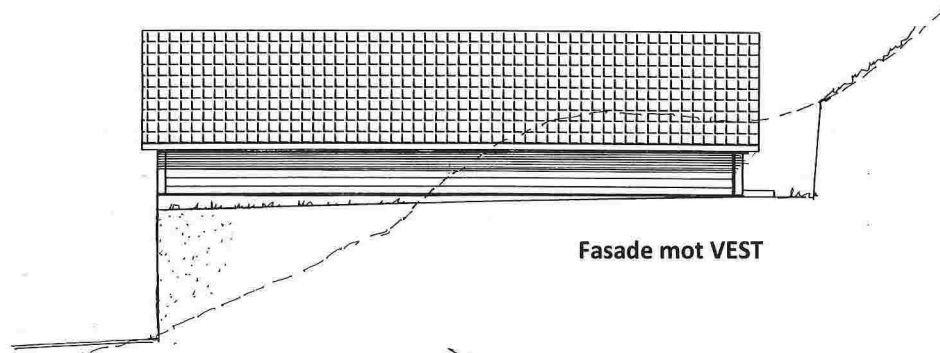
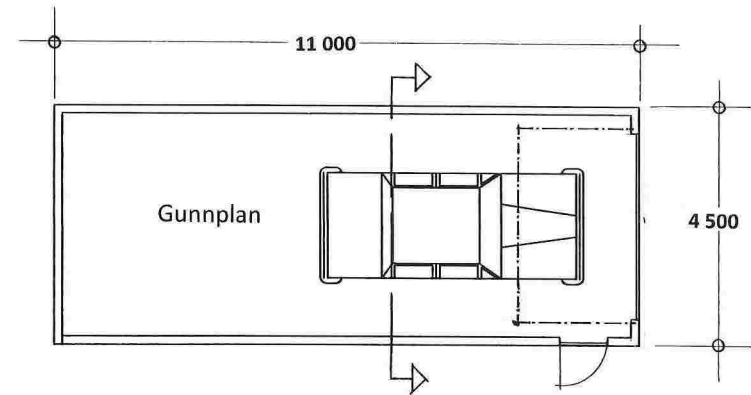

Fasade mot VEST

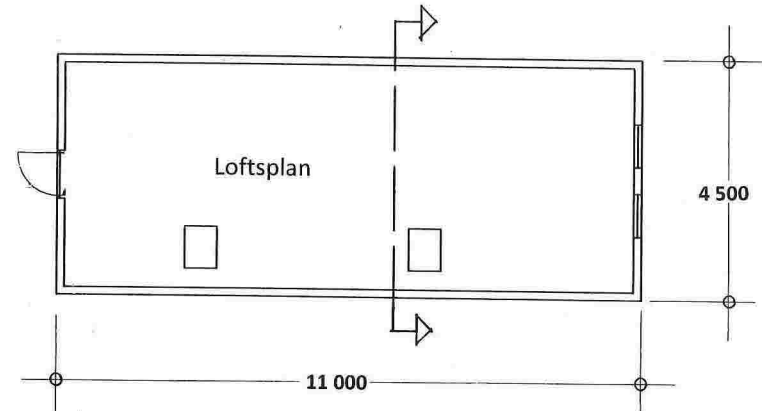

Fasadfe mot NORD

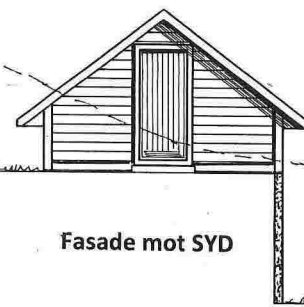

Fasade mot SYD

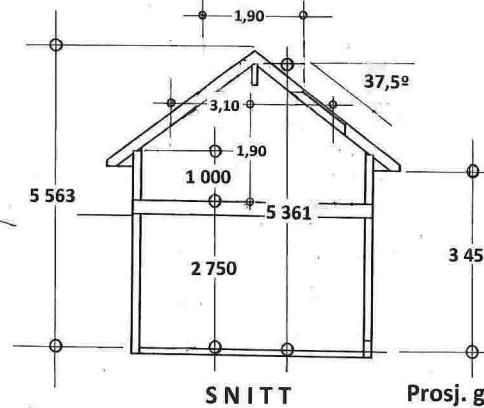

SNITT

BYA 49,5 m²

BTA 49,5 m²

BRA 80 m²

Prosj. garasje på Gnr. 10 , Bnr. 255 i Meland kommune

Plan , Snitt – og Fasader i Mål = 1 : 100

Isdalstø , 31. 08. 2016



Byggteam Vest AS

E-1

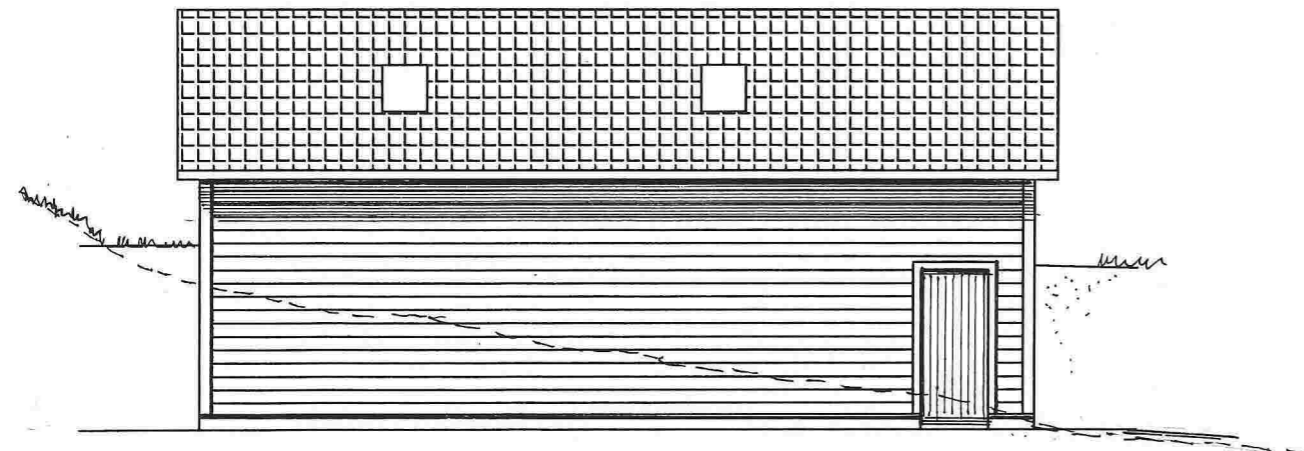

Fasade mot ØST

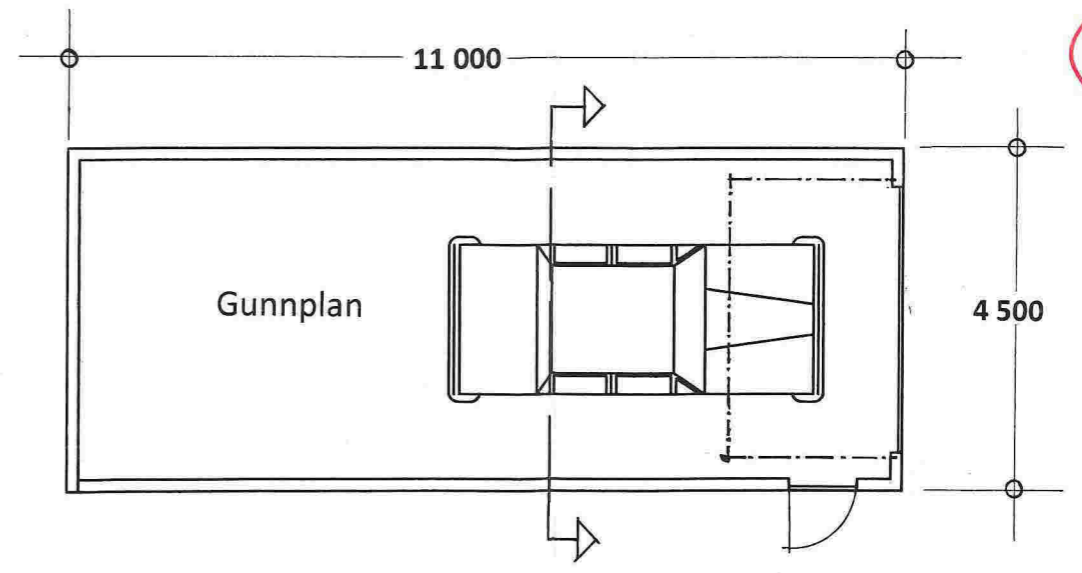

Gunnplan

4 500

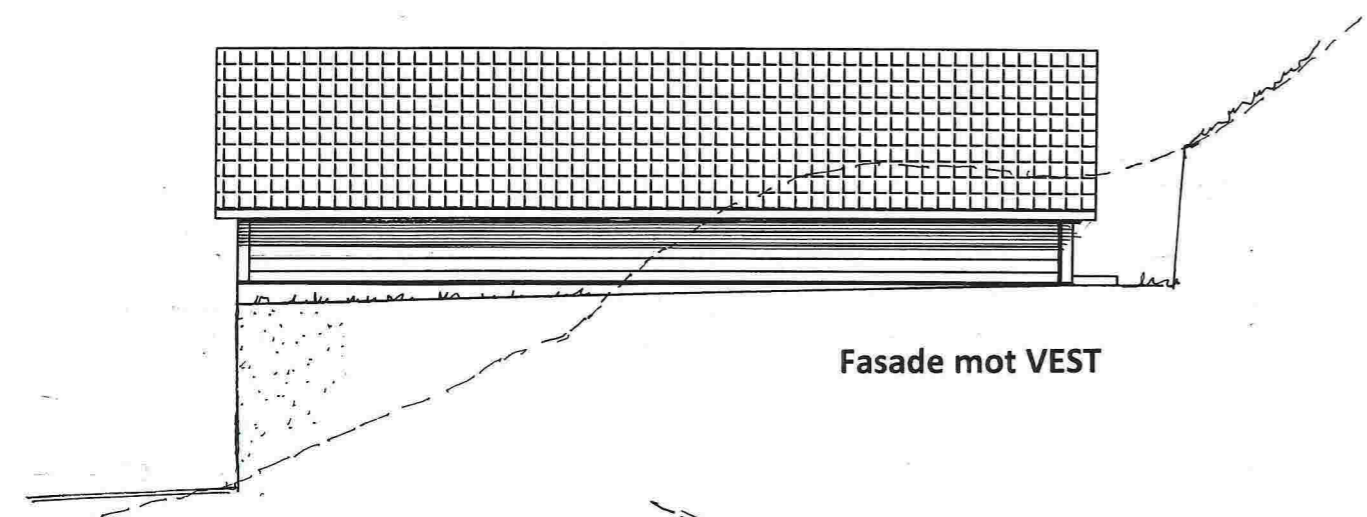

Fasade mot VEST

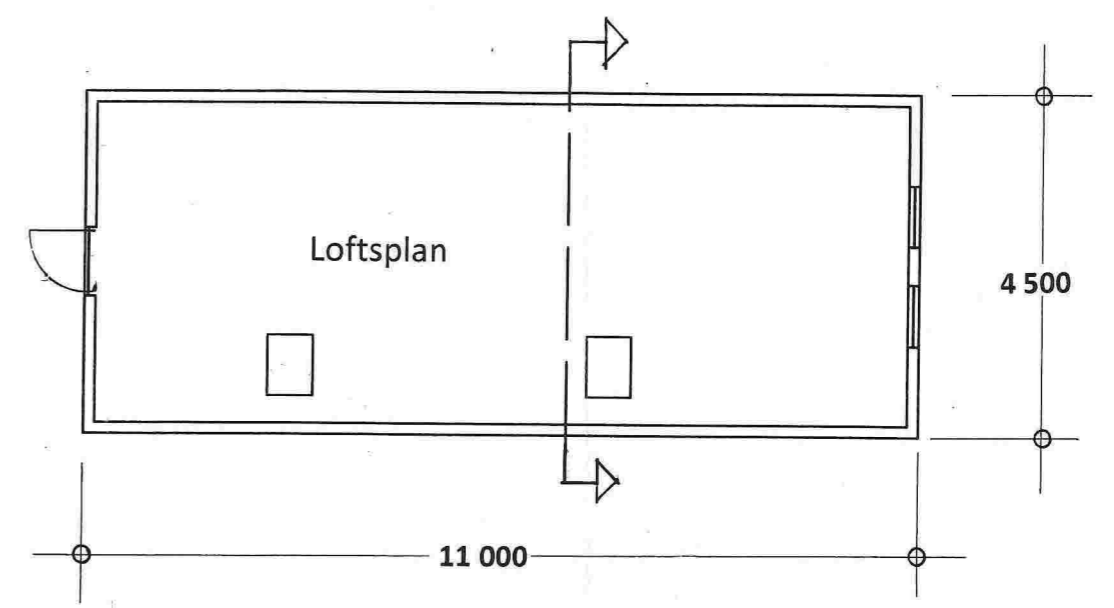

Loftsplan

4 500

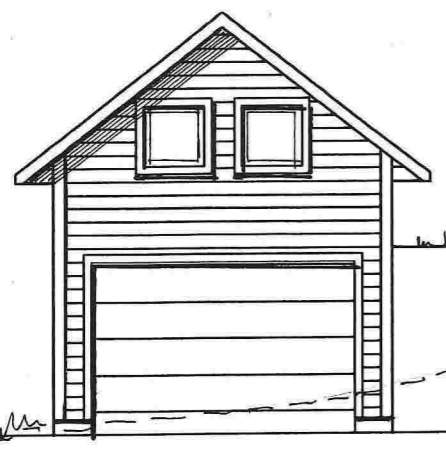

Fasadfe mot NORD

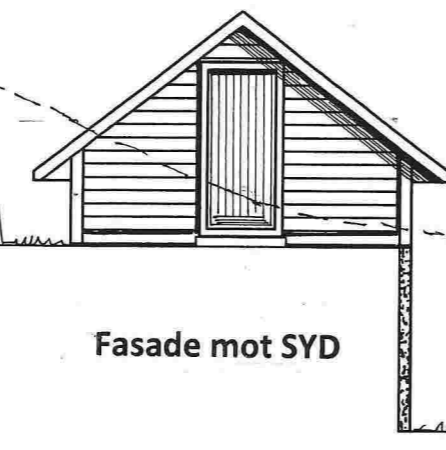

Fasade mot SYD

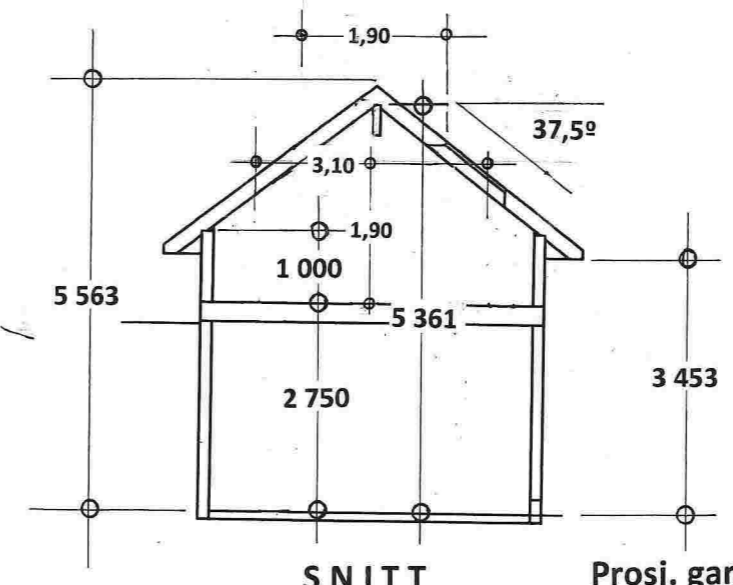

SNITT

BYA 49,5 m²

BTA 49,5 m²

BRA 80 m²

Prosj. garasje på Gnr. 10 , Bnr. 255 i Meland kommune

Plan , Snitt – og Fasader i Mål = 1 : 100

Isdalstø , 31. 08. 2016

Byggteam Vest AS



100



100