

Bod

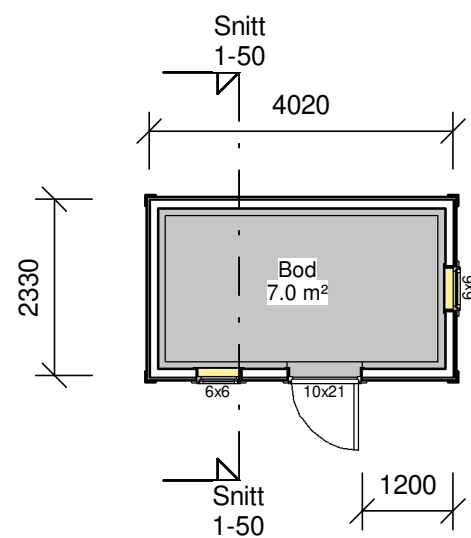

Snitt

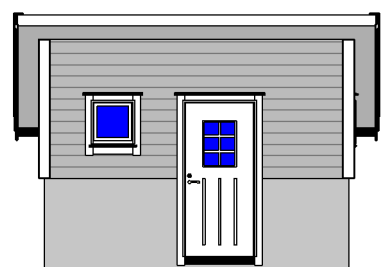
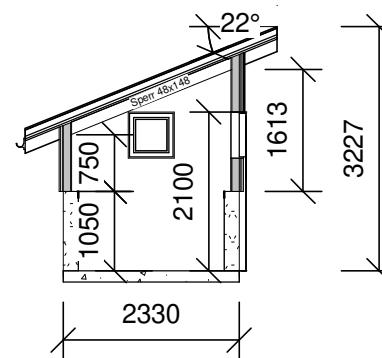

FASADE MOT SØR

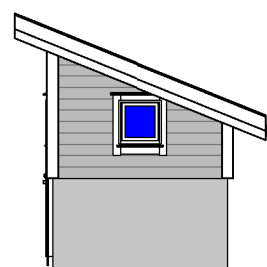

FASADE MOT ØST

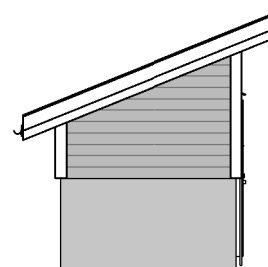

FASADE MOT VEST

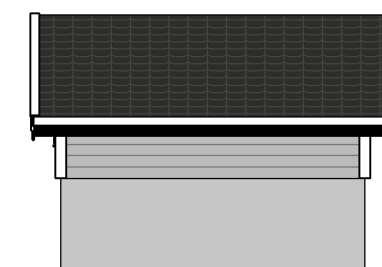

FASADE MOT Nord

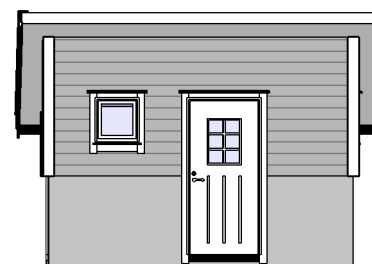

3D Modell

BRA	7 m <sup>2</sup>
BYA	9 m <sup>2</sup>

REV.	DATO	REVISJON	SIGN.
A	27.04.20	Endret takvinkel	

**Kålås Bygg AS**  
 Torvhusmyrane 2, 5913 Eikangervåg  
**MESTERHUS**

TILTAKSHAVER:	Helge Hellem
BYGGEPLASS:	Storneset 24
G.nr/B.nr:	195/181
KOMMUNE:	Alver

TEGN, INNHOLD:	Plan, snitt, Fasade og 3D	TILTAKSART:	MÅL:
PROSJEKT:	<b>Helge Hellem</b>		1 : 100
ARKITEKT:	Espen Tvedt	DATO:	08.04.20
		TEGN:	ET
		PROSJEKT NR:	TEGN.NR:
			<b>09.01</b>