



D-1



Situasjonskart - gbnr 349/151

Dato: 12-05-2020



Målestokk: 1:500



E-1

PLAN

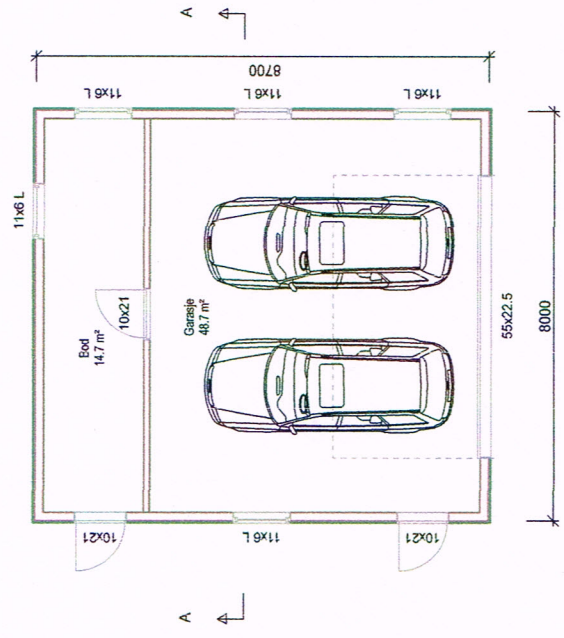

PLAN LOFT

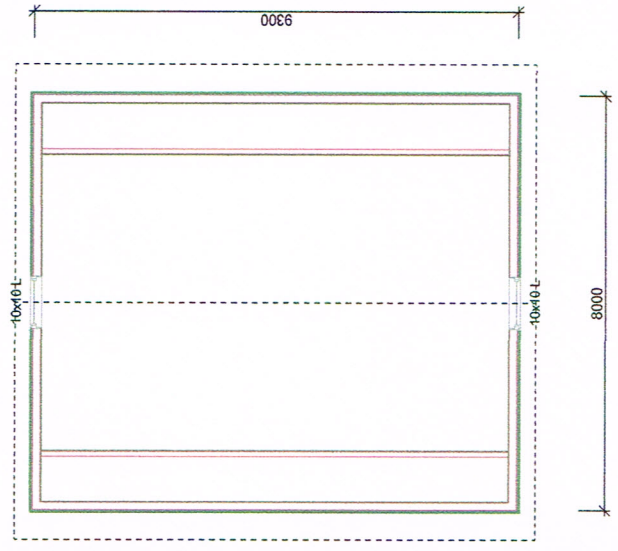

SNITT A - A

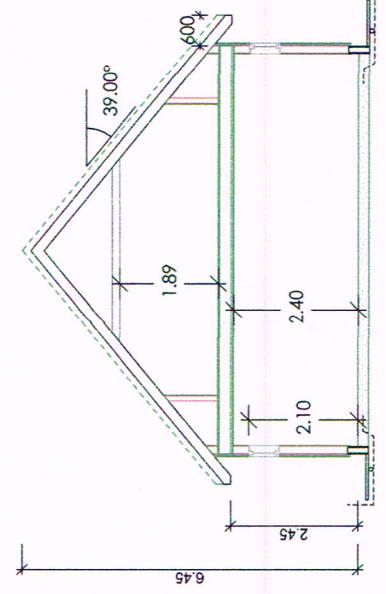

AREALER:  
 BYA = 69,6 m<sup>2</sup>  
 BRA = 64,3 m<sup>2</sup>

Garasje iden

DVA DESIGN SYSTEM	
Tiltskriver:	Geir Iden
Bygningsclass:	Levegen 184 B
Kommune:	Meland
Gar. 349	Bnr. 151
Mål:	1 : 100 / A3
Prosjekt nr.:	
Tegning nr.:	501
Garasje iden	
Fjeldstad & Sandvik	
TOMRISTEAM	
Tegningene er beskyttet i.h.t. for. og opphavsrett.	
Dato:	25.05.2020
Tegn.:	RF
Garasje iden	

E-2

FASADE: Øst

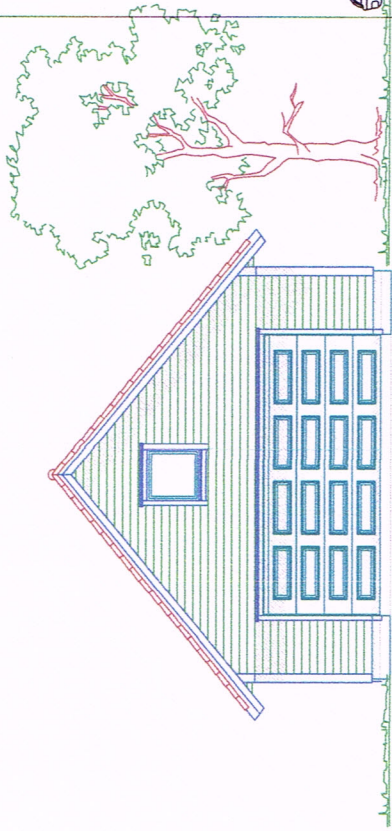

FASADE: Nord

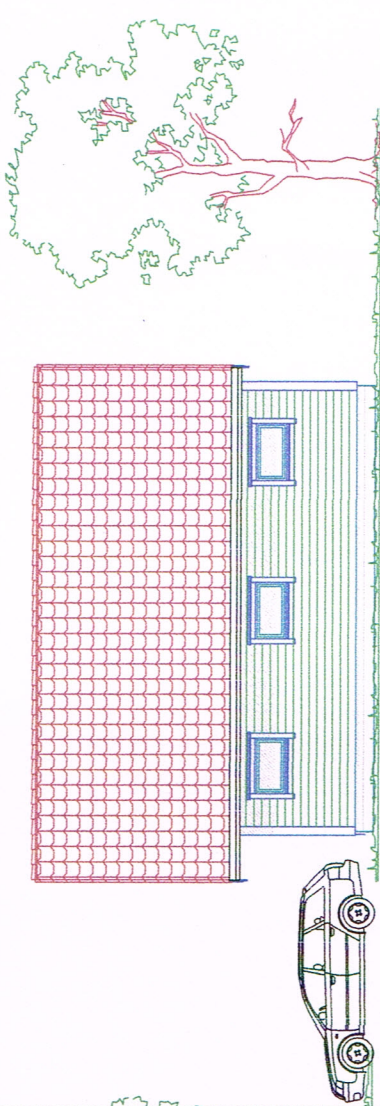

FASADE: Vest

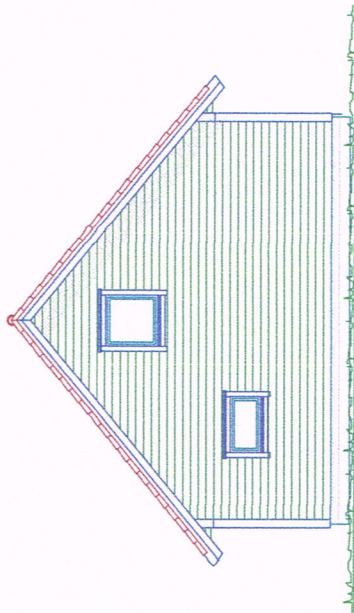

FASADE: Sør

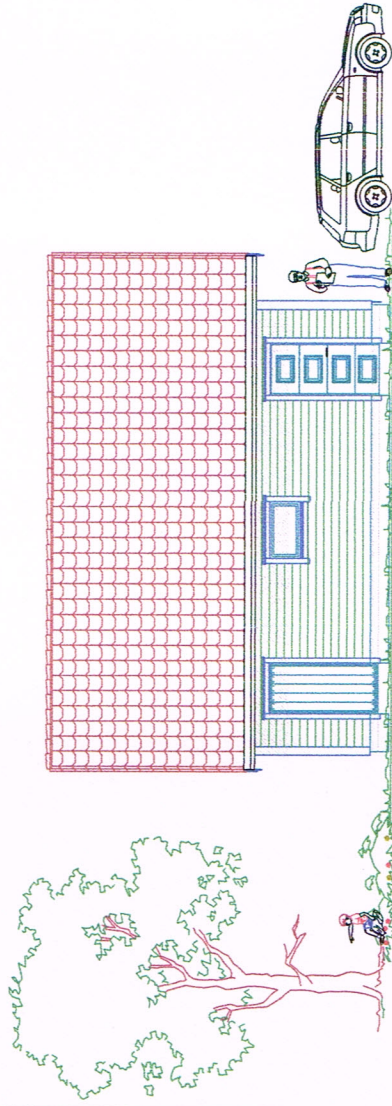

Garasje Iden

DIVA DESIGN SYSTEM

Tilleshaver: Geir Iden

Byggeklasse: Levegen 184 B

Kommune: Meland

Gar. nr. 349 Bnr. 151 Mål. 1 : 100 / A3

Fasader

Fjeldstad & Sandvik  
Landskapsarkitektur

© Tegningene er beskyttet i.h.t. lov om opphavsrett.

Dato: 25.05.2020  
Tegn: RF  
Prosjekt nr.:  
Tegn.nr.: 502

Garasje Iden

E-3

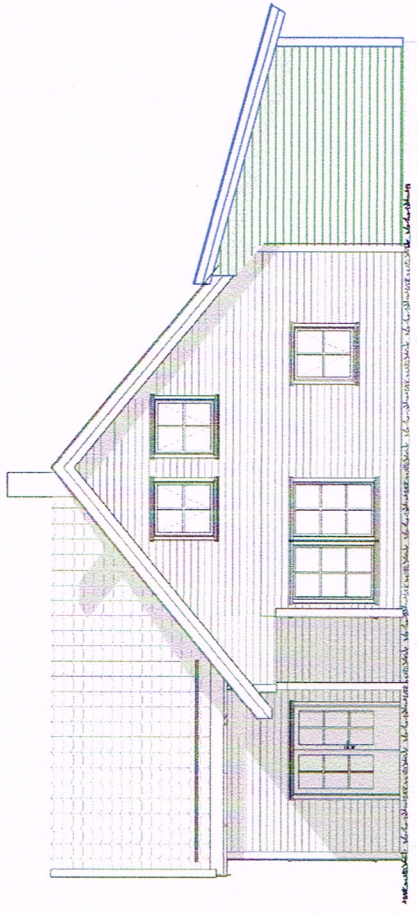

FASADE mot sør

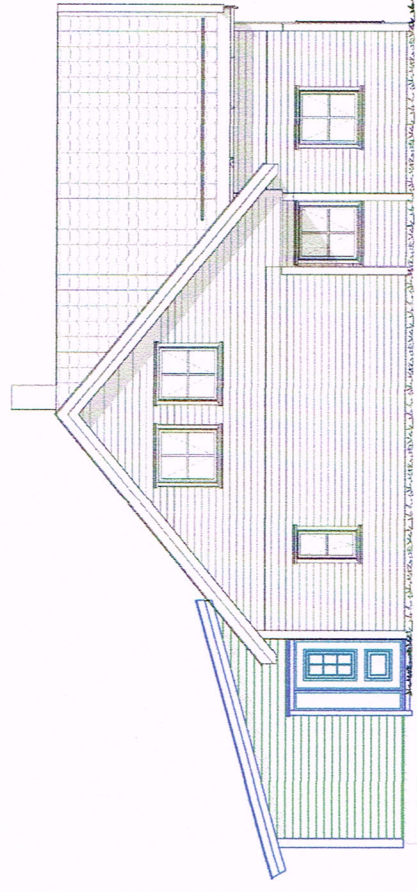

FASADE mot nord

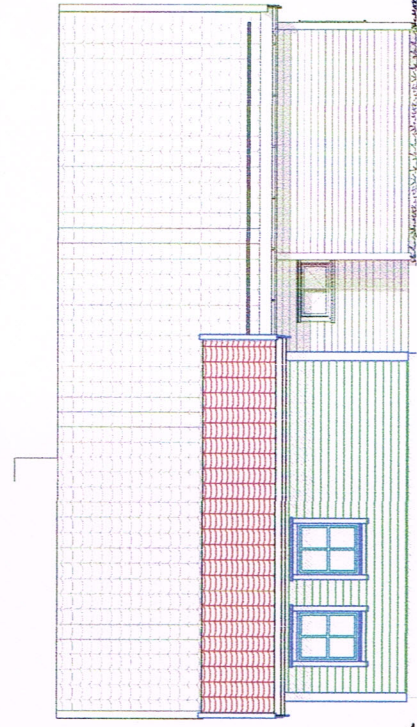

FASADE mot øst

Tilbygg Iden



Tillegsktaver	Geri Iden og Malin Sagstad	Dato	11.11.2020
Byggeklasse	Levegen 184 B	Tegn	RF
Kommune	Alver	Prosjekt nr.	
Grnt.	349	Blnt.	151
Målt.	1 : 100 / A3	Tegn nr.	502
Fasader			Tilbygg Iden

Fjeldstad & Sandvik  
LØSNINGSUTVIKLERE

© Tegningene er beskyttet i henhold til lov om opphavsrett.

E-4

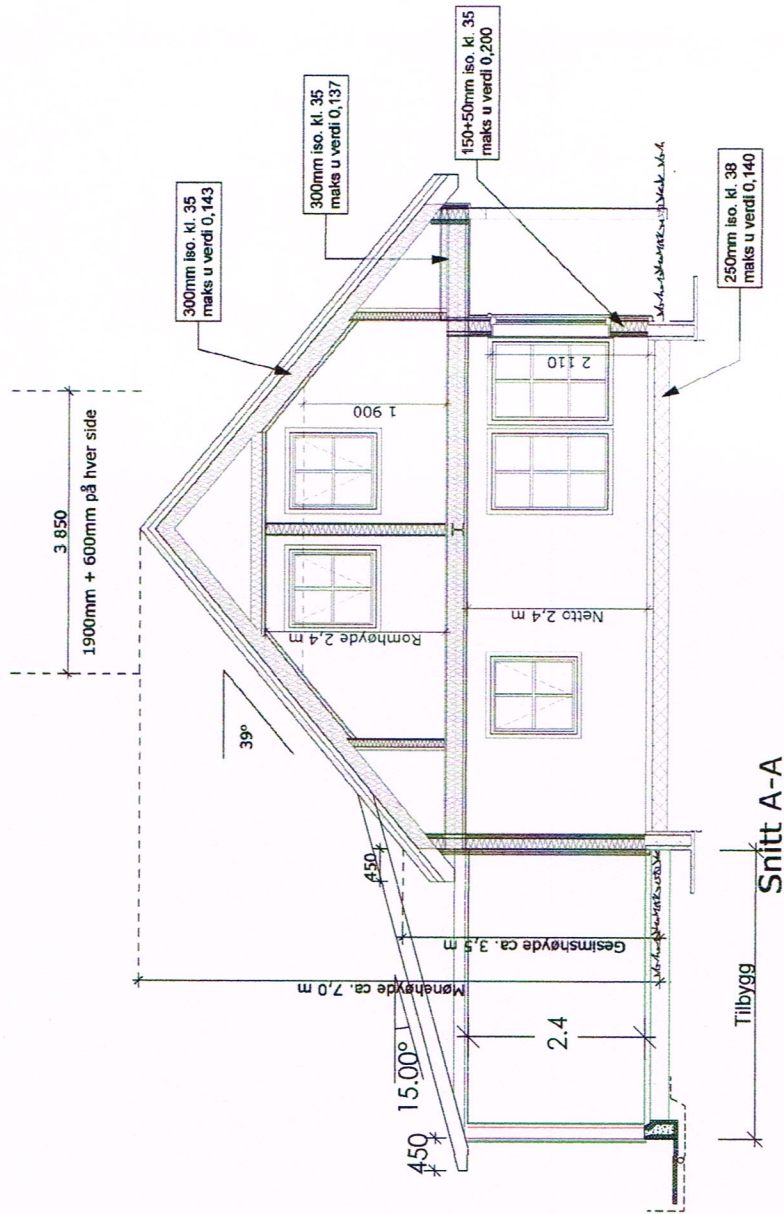

Tilbygg Iden

DATA DESIGN SYSTEM

Tiltakshaver: Geri Iden og Malin Sagstad

Byggeplass: Ievengen 184 B

Kommune: ALVØR

Gnr: 349 Bnr: 151 Måt: 1 : 100 / A4

Snitt

Dato: 11.11.2020

Tegn: RF

Prosjekt nr.:

Tegm.nr: 503

Tilbygg Iden

Fjeldstad & Sandvik  
TØMRERTEAM

© Tegningen er beskyttet i.h.t. lov om opphavsrett.

E-5

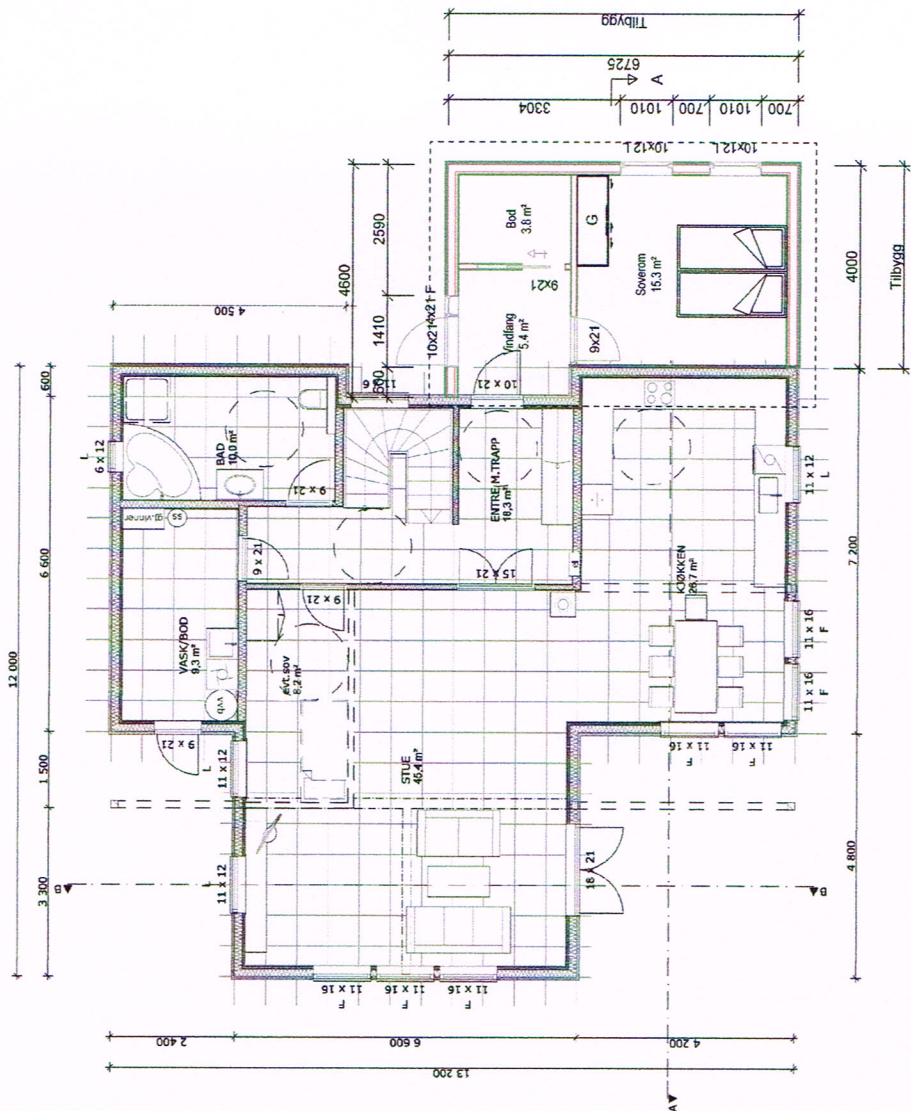

BYA tilbygg = 28,3 m<sup>2</sup>

BRA tilbygg = 25,2 m<sup>2</sup>

Tilbygg iden



Tilbakshavar: Gerli iden og Malin Sagstad

Bruksblass: Levegen 184 B

Kommune: Alver

Snr: 349 Brn: 151 Mål: 1 : 100 / A3

Plan



Tegningen er beskyttet iht. bygningsloven.

Date: 11.11.2020  
Tegn: RF  
Prosjekt nr.:  
Tegn.nr.: 501

Tilbygg iden