

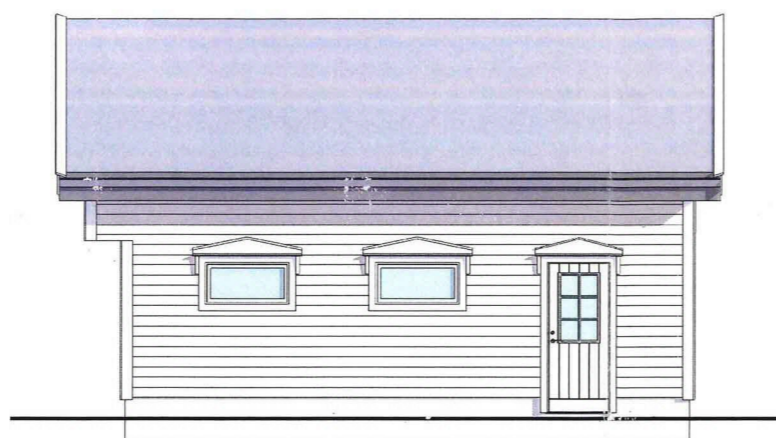

1 Fasade mot vest
1 : 100

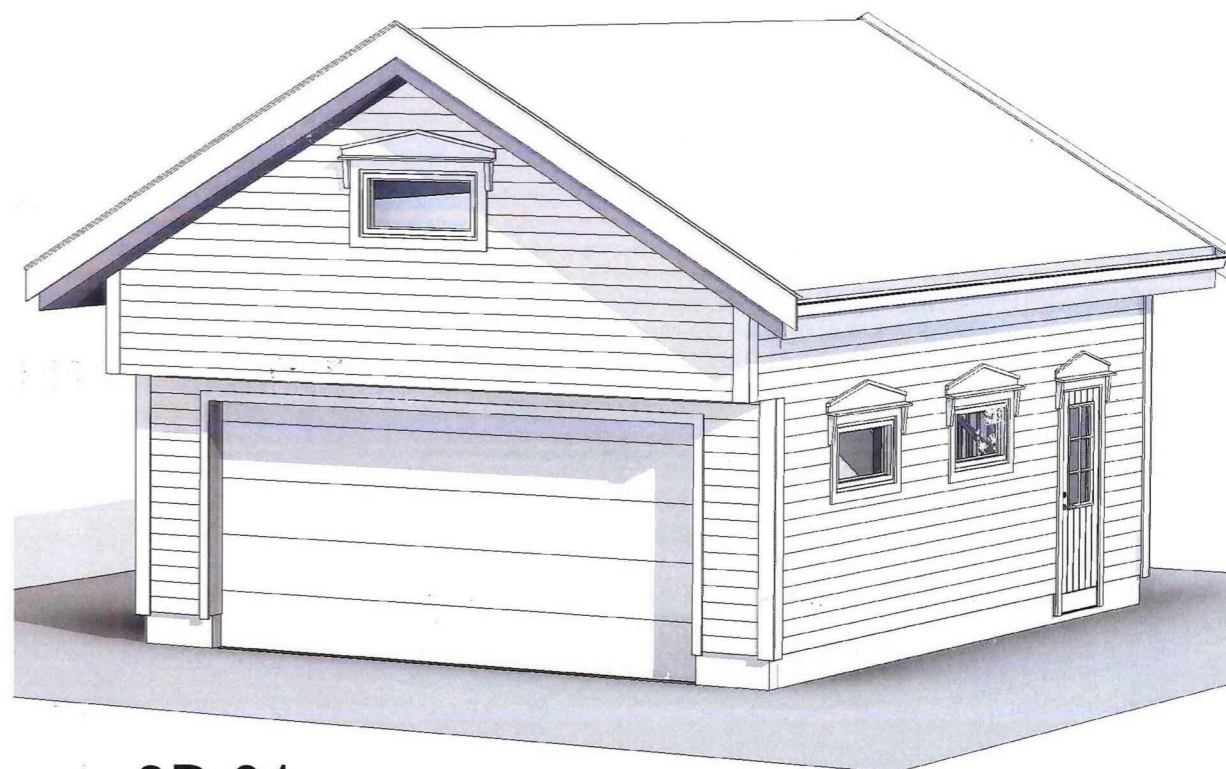

2 Fasade mot sør
1 : 100



5 3D 01

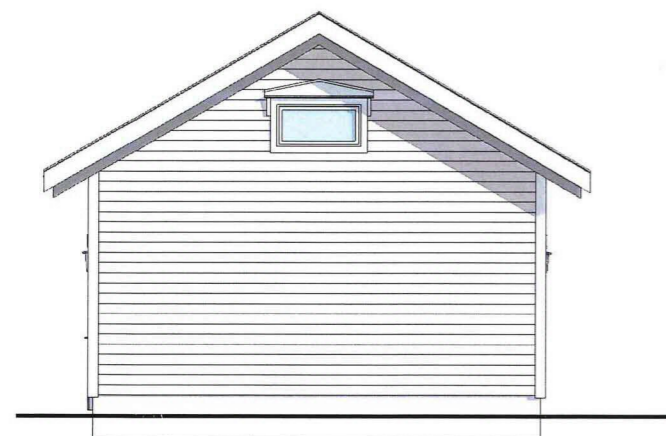

3 Fasade mot øst
1 : 100

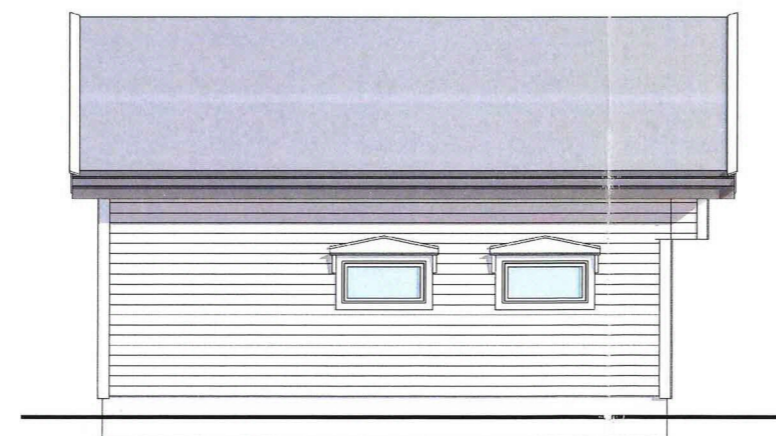

4 Fasade mot nord
1 : 100

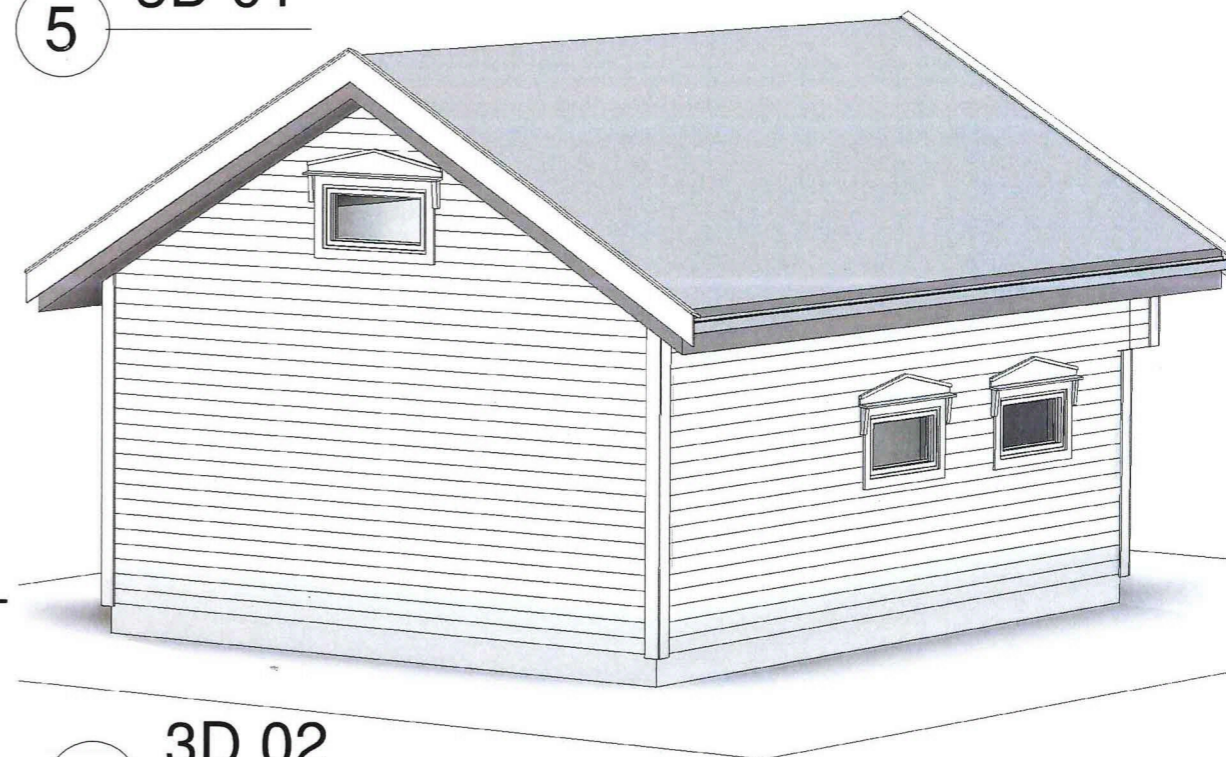

6 3D 02

Dato 20.10.2020	DAK R. Sætre	Målenhet mm	Målestokk A3	Oddvar Haukeland Vetåsvegen 43, 5938 Sæbøvågen
Filnavn -	Underlag -	Godkjent -	1:100	
Garasje GBnr.: 484/1, Alver kommune. Vetåsvegen 43. Fasade og 3D				01698-A102A
				GAD SERVICE VEST tlf 930 124 35 fax 401 150 66 www.CadServiceVest.com

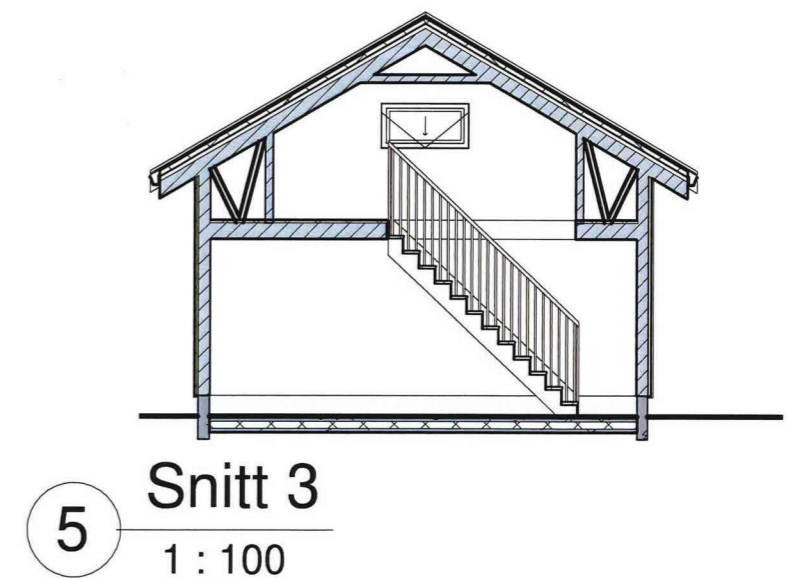
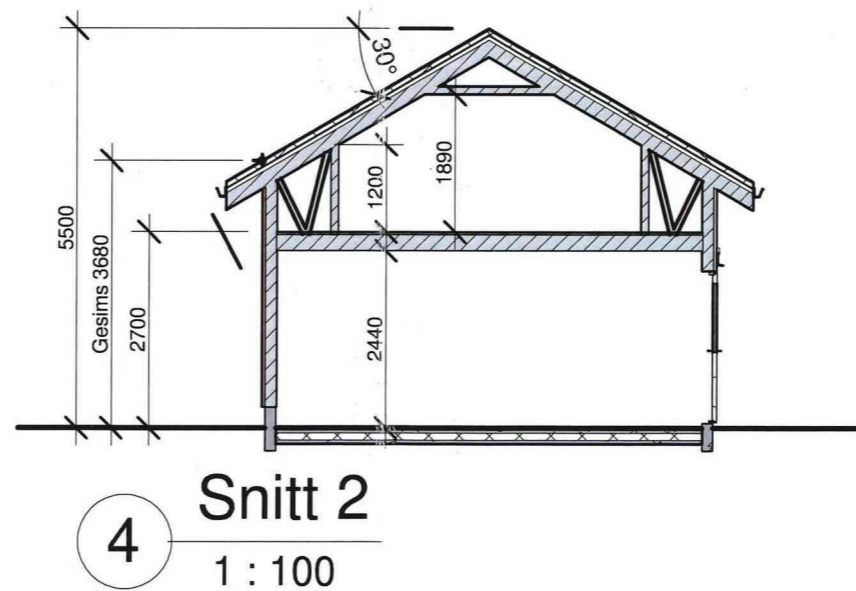
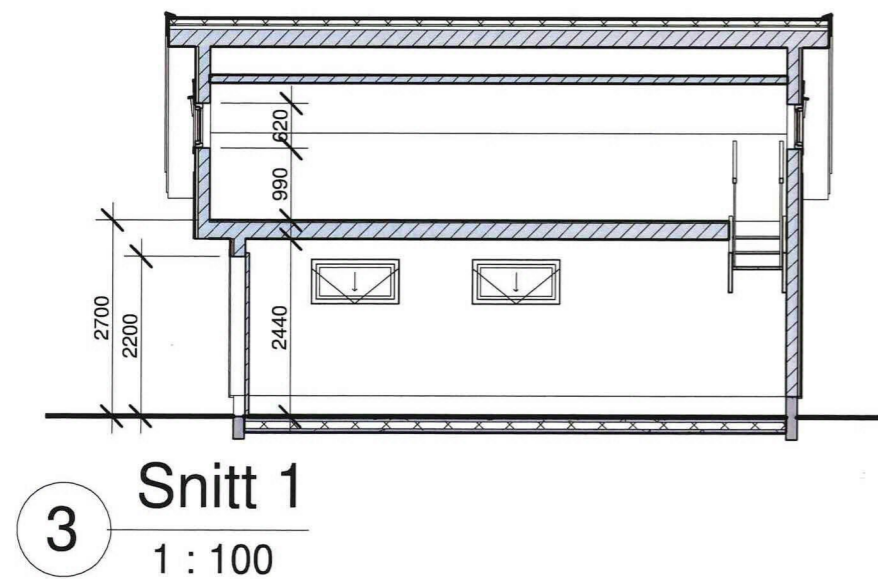
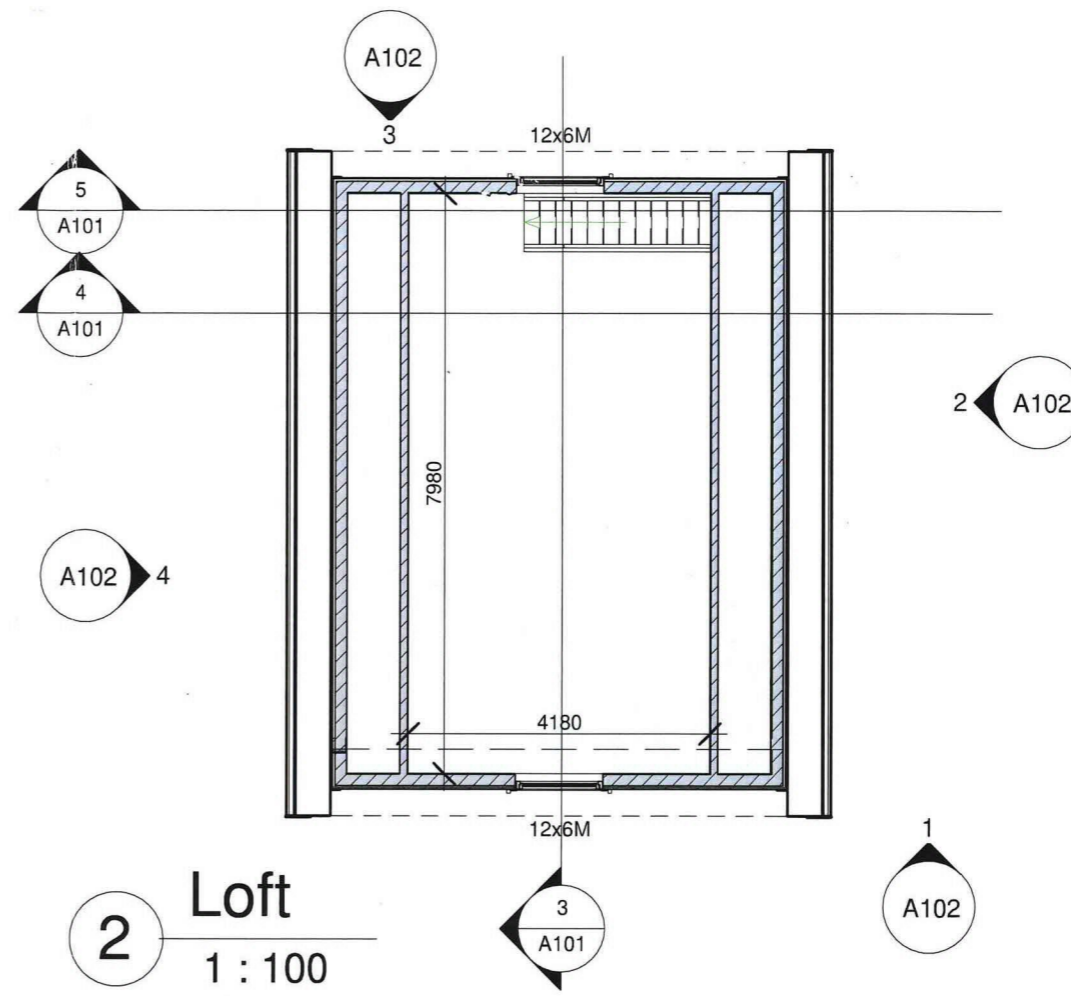
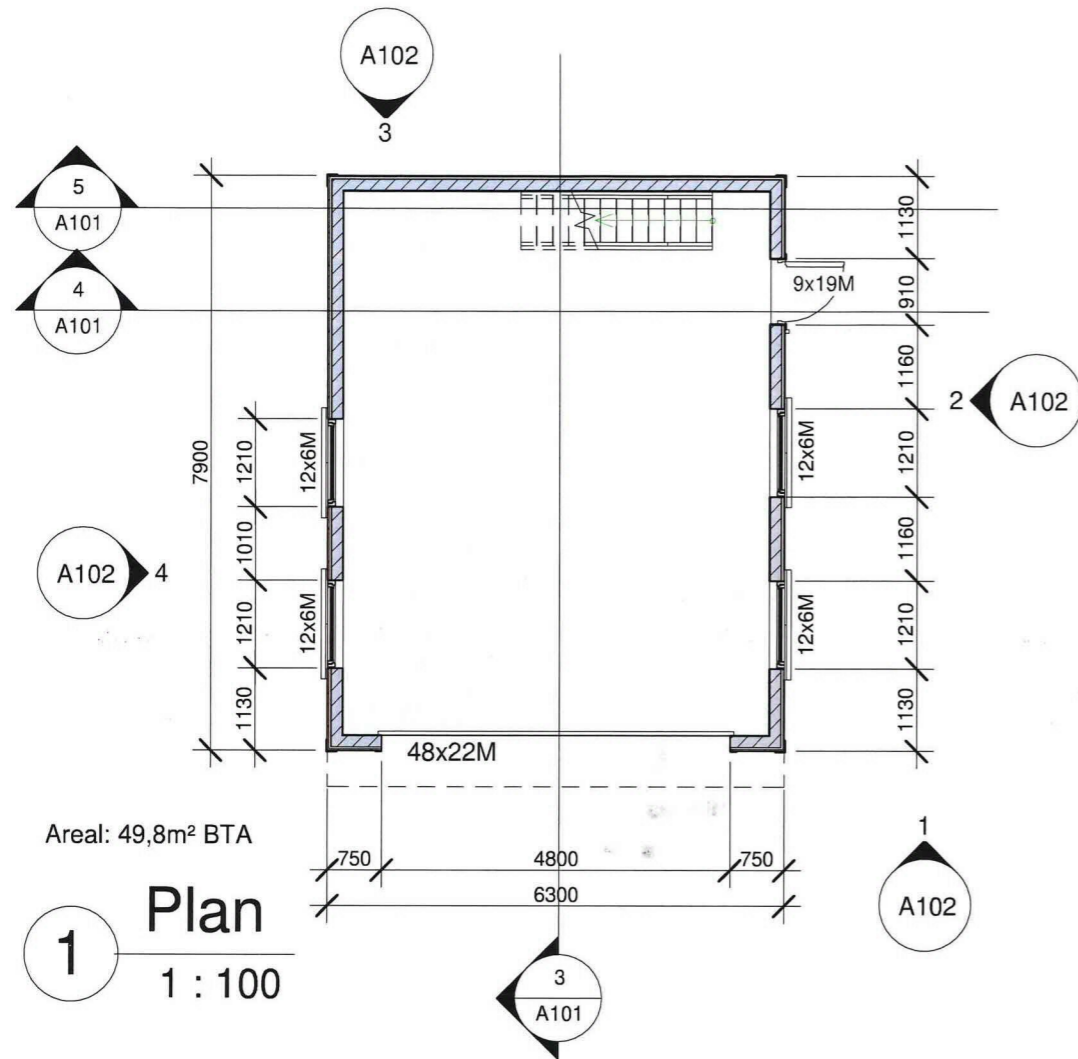

Dato 20.10.2020	DAK R. Sætre	Målenhet mm	Målestokk A3 1:100	Oddvar Haukeland Vetåsvegen 43, 5938 Sæbøvågen
Filnavn -	Underlag -	Godkjent -		
Garasje GBnr.: 484/1, Alver kommune. Vetåsvegen 43. Plan og snitt				01698-A101A
CAD SERVICE VEST tlf 930 124 35 fax 401 150 66 www.CadServiceVest.com				

4.