

PLAN-OG SMITTEGNINGER IHT Godlygent løyve
av 11.06.2020

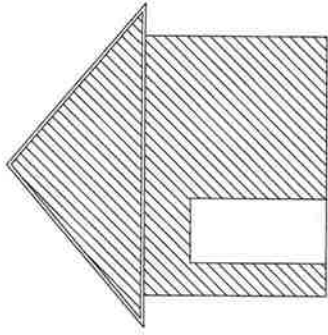

UT MOT SJØ

INNGANGSPARTI

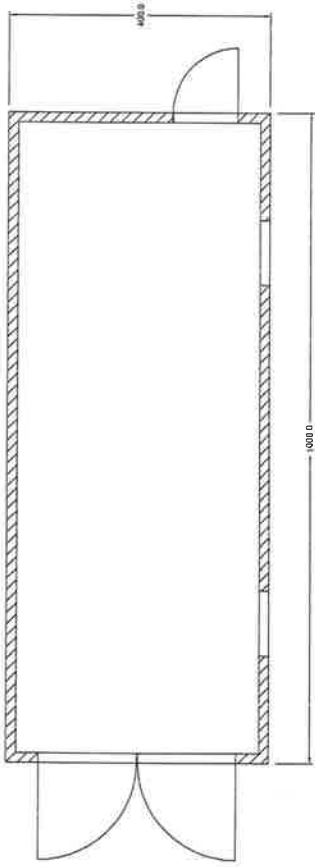
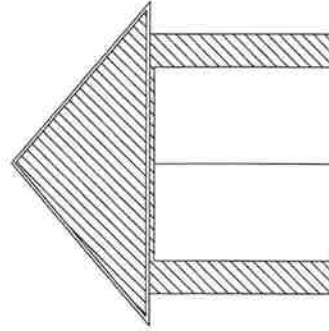
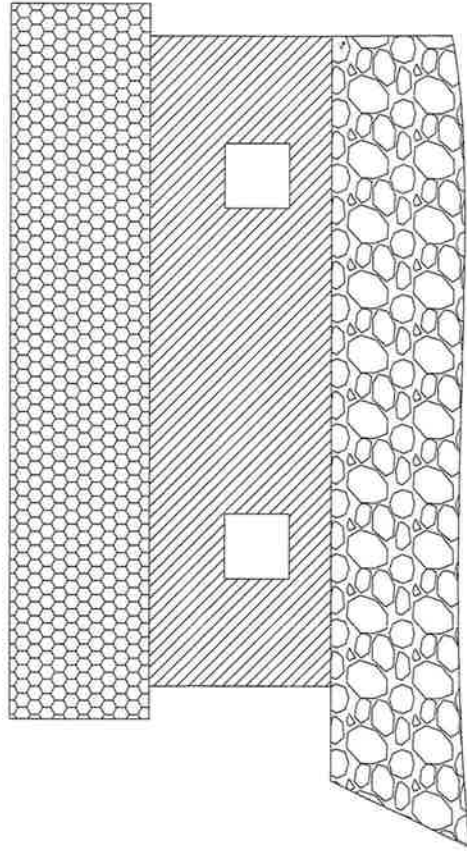

UT MOT SJØ

SNITT

NAUST ER VENDRET FRA Godkjenneise av 11.06.2020

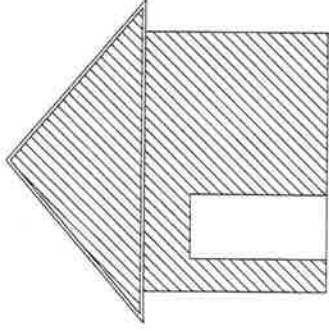
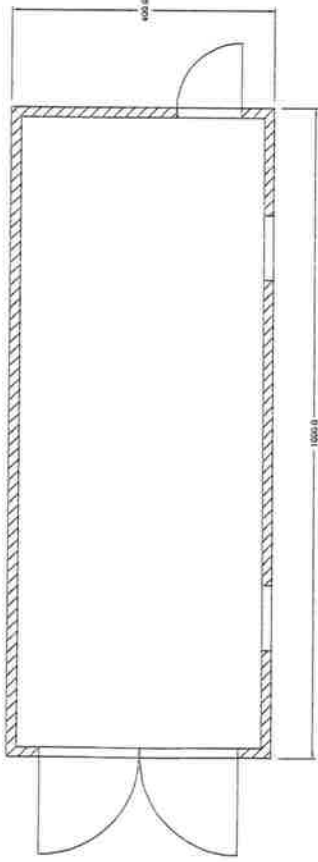

UT MOT SJØ

INGANGSPARTI

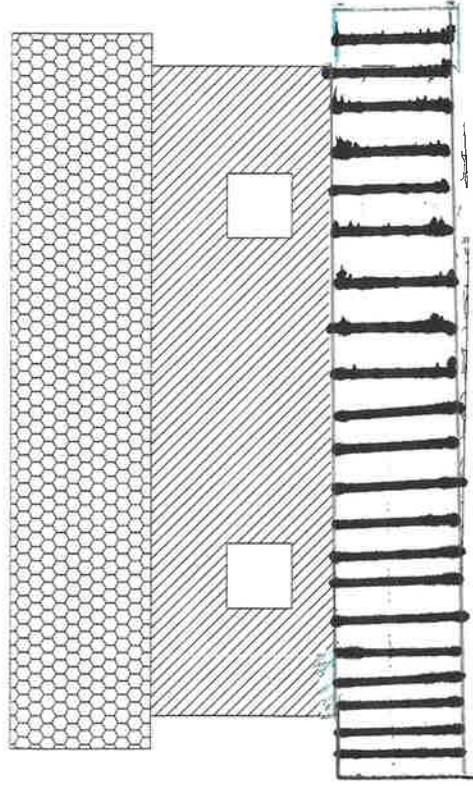

UT MOT SJØ

SNITT

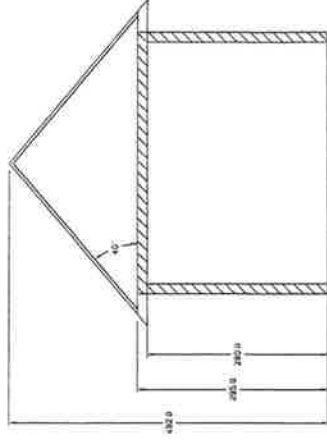

Utvidelse av grunn fra 10m \rightarrow 12m i nyde
Ringmur i betong.