

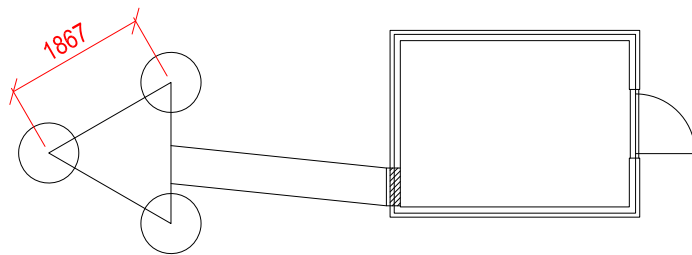

# Mast ST-A høyde 24m

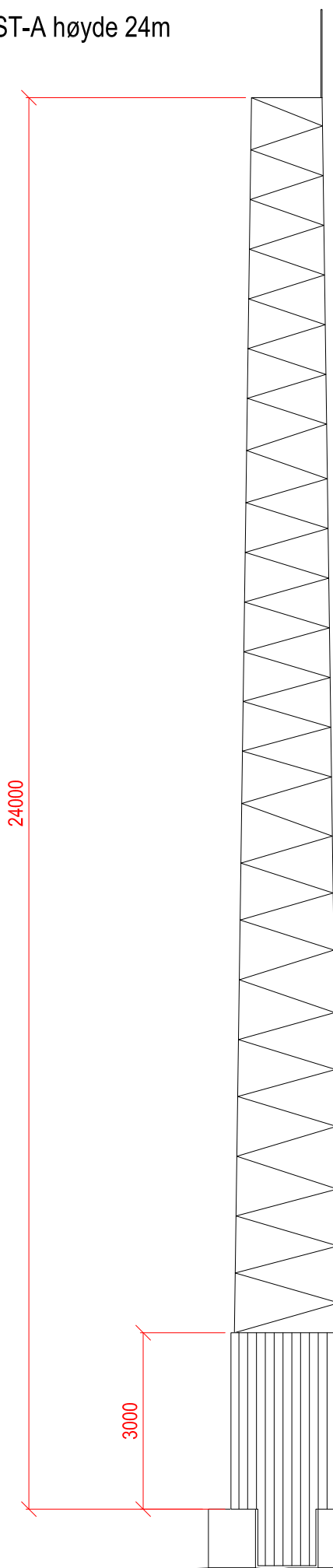

Plan: Samenstilling sett ovenfra.  
Målsetting for hytte ses på egen tegning.

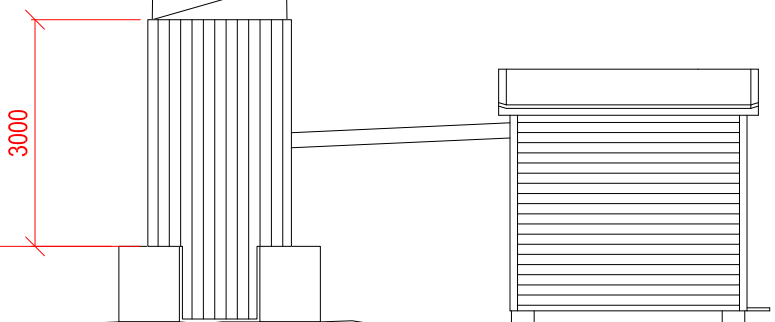

	Site name Trollhaugane OPPRISS / SAMENSTILLINGSTEGNING HUS MAST	Site owner TELENOR NORGE AS Mast&Tower
	Gnr. og Bn. For./Kommune: Document Info Byggesaktegning 1 av 2	Site signature TROLLHA
	Scale: M 1:100	

# TM3-hytte

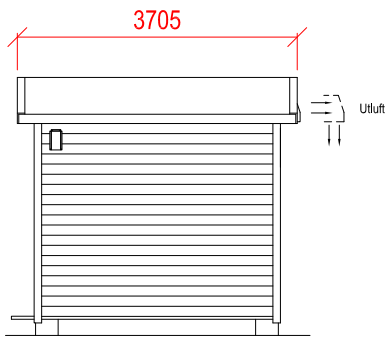

**Sidefasade 1**

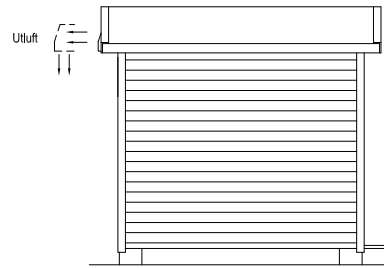

**Sidefasade 2**

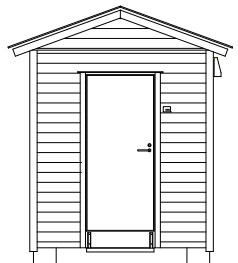

**Frontfasade**

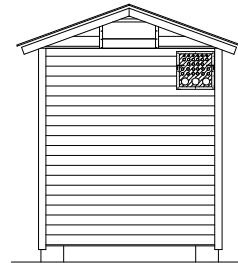

**Bakfasade**

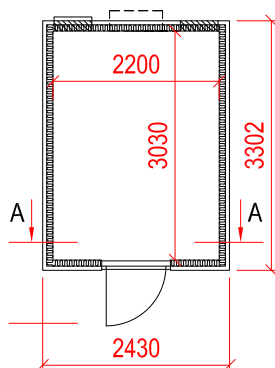

**Plan**

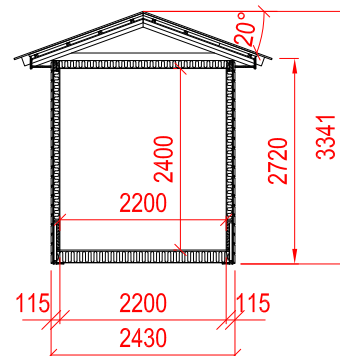

**Snitt A-A**

	Site name Trollhaugane Hyttetegning	Site owner TELENOR NORGE AS Mast&Tower
	Grn. og Bm. Fir./Kommunic.	Site signature TROLLHA
Document info Byggesakstegning 2 av 2	Scale: M 1:100	Date: 17.02.2021
		Changed date
		Revision number