

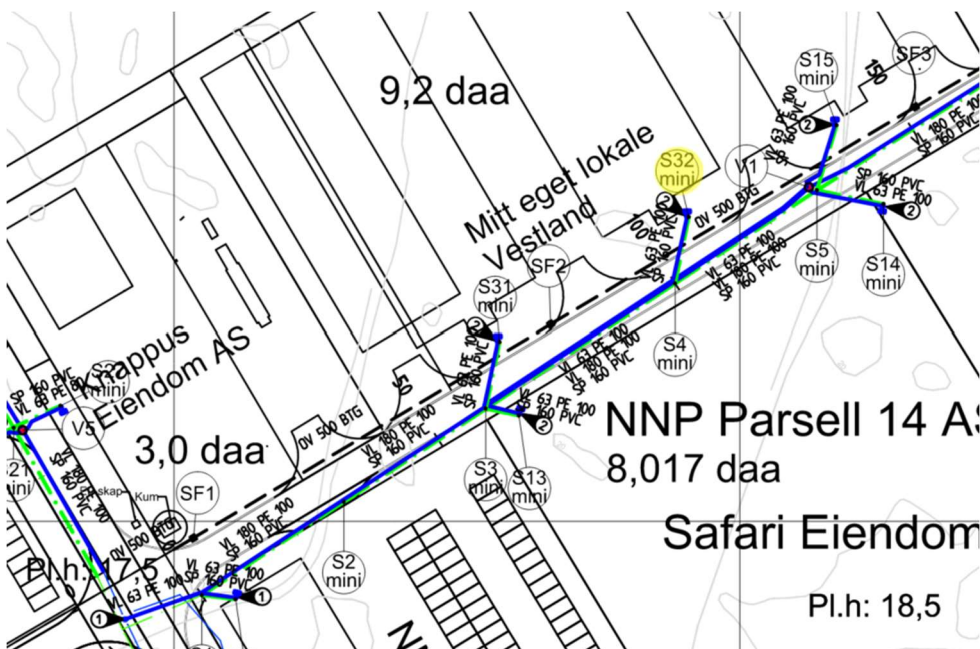

Kumkort			
Tiltakshaver:	ATR eiendom,	Side:	1 av 4
Ansvarlig utførende:	Flage Maskin as	Sist rev.	18.02.2022
Prosjekt:	Nordhordaland Næringspark VA	Dok.Id:	030610-061 B
Prosjektnr.:	21033	Dato /sign.:	

Anleggssted	Nordhordaland Næringspark
Dato	18.02.2022
Registrert av	Mari Røen
Kumnr.	S32



KUMDATA

Kumform	R (Rund)
Kumbredde Innvendig diameter (mm)	400
Bunnseksjon	Rettløp
Kjegle	U (uten kjegle)
Byggethode	W (PP (polypropylen))
Produsent	Kaczmarek
Stige	Nei
Drenering	U (ingen drenering)

Kumkort		 <small>Bjørkemoen 46 5700 VCS T.L.F. 56 63 02 00 – FAX 56 63 02 10 MOB 46 40 70 70 – www.flagemaskin.no</small>	
Tiltakshaver:	ATR eiendom,	Side:	2 av 4
Ansvarlig utførende:	Flage Maskin as	Sist rev.	18.02.2022
Prosjekt:	Nordhordaland Næringspark VA	Dok.Id:	030610-061 B
Prosjektnr.:	21033	Dato /sign.:	

Kumskisse, bilde nr. 1

Kommentar til skisse: Bunnseksjon har rettløp

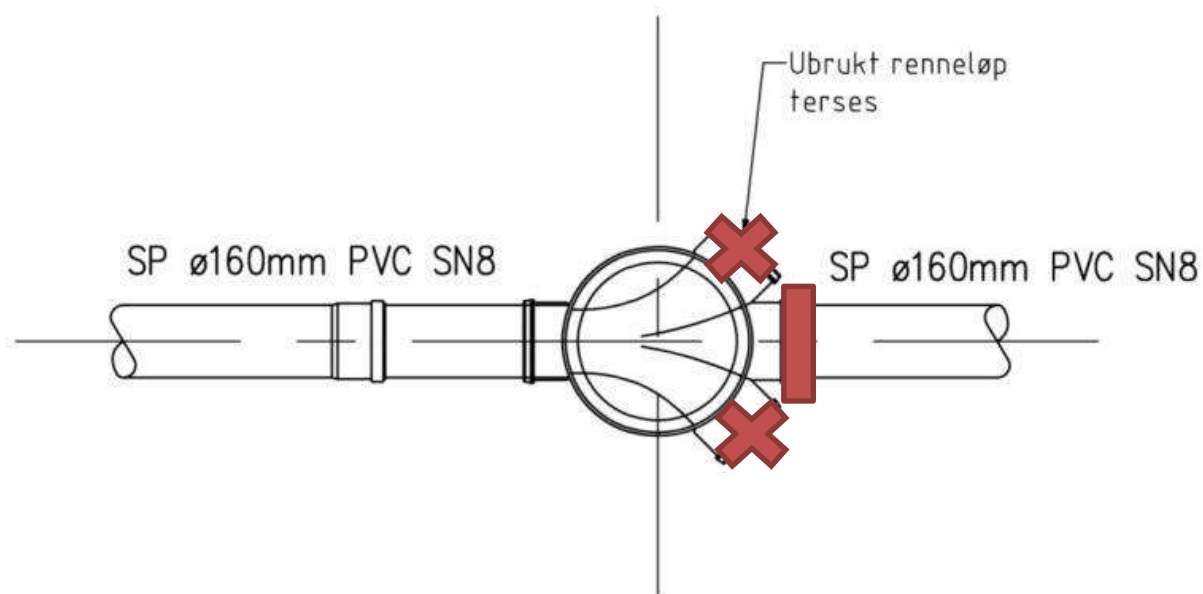

PLAN MINISTAKEKUM

18.02.2022 14:14

M=1:20

Kumkort			
Tiltakshaver:	ATR eiendom,	Side:	3 av 4
Ansvarlig utførende:	Flage Maskin as	Sist rev.	18.02.2022
Prosjekt:	Nordhordaland Næringspark VA	Dok.Id:	030610-061 B
Prosjektnr.:	21033	Dato /sign.:	

Kumskisse, bilde nr. 2

Kommentar til skisse: Bunnseksjon har rettløp

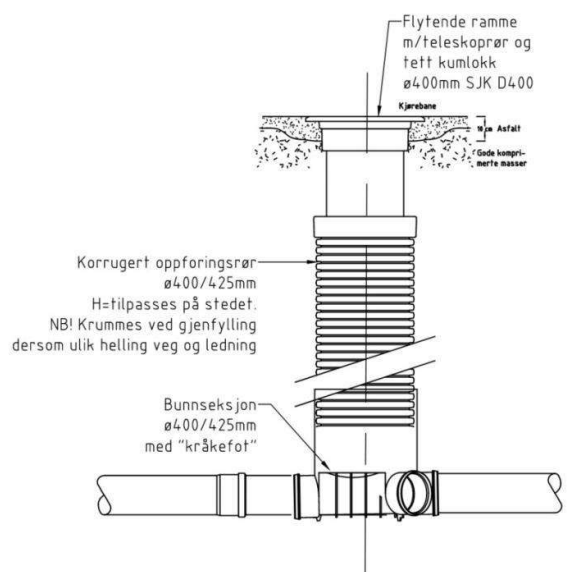

SNITT MINISTAKEKUM
M=1:20

18.02.2022 14:14



Kumkort		 <small>Bjørkemoen 46 5120 VCS TLF.55 63 02 00 – FAX.55 63 02 10 MOB.46 40 70 70 – www.flagemaskin.no</small>	
Tiltakshaver:	ATR eiendom,	Side:	4 av 4
Ansvarlig utførende:	Flage Maskin as	Sist rev.	18.02.2022
Prosjekt:	Nordhordaland Næringspark VA	Dok.Id:	030610-061 B
Prosjektnr.:	21033	Dato /sign.:	

