

18-March-2016

NORD

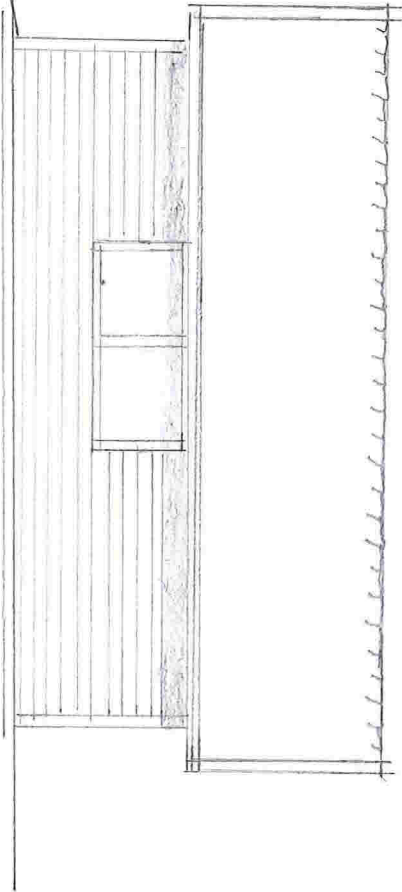

SØR

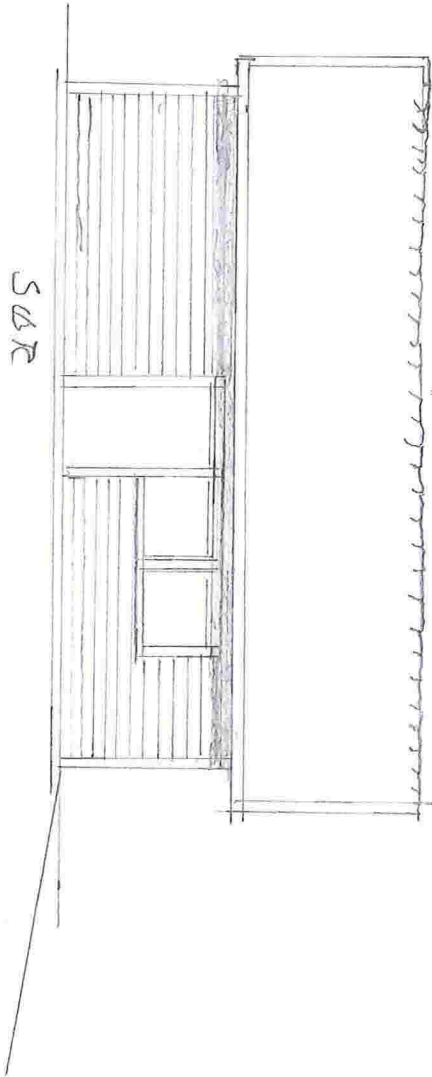

550

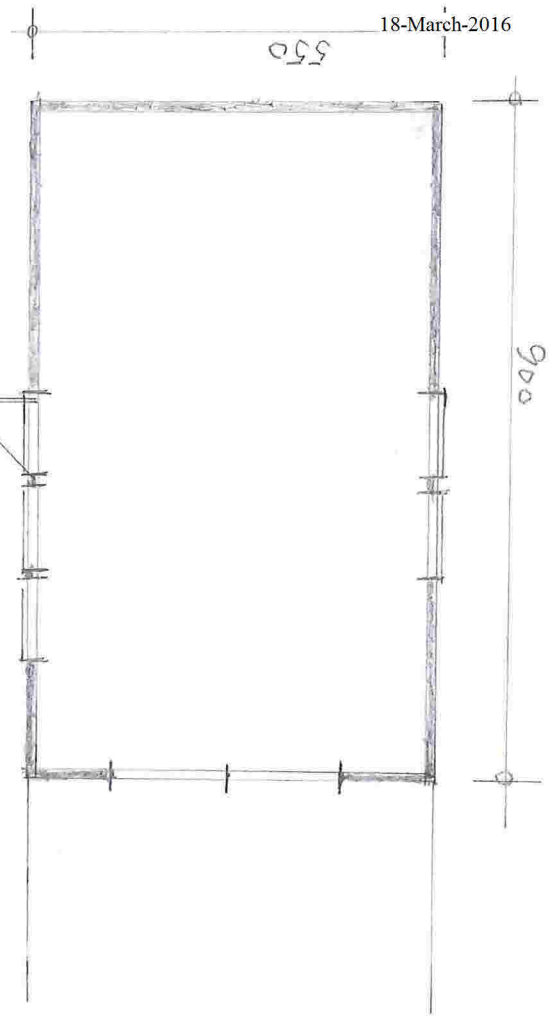

900

AUST

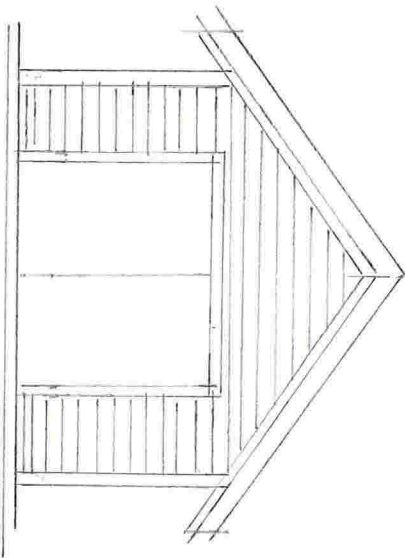

VEST

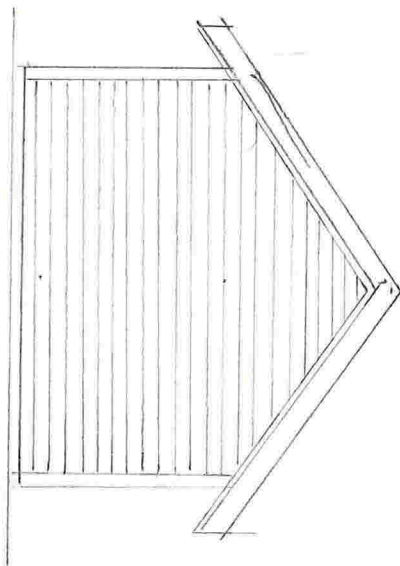

280

500

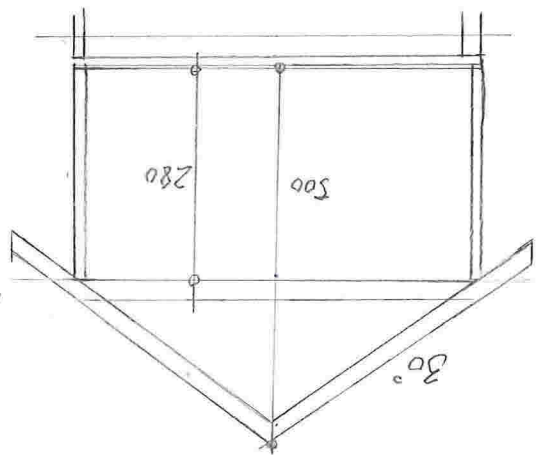

30°

TILTAKSIT ANN & EGIL AVSTBØ

NAUST GRUNNPL. 49.5 m²

MALESTOKK 1:100

DATO 01.03.2016

GNR 234 BNR 99 LINDÅS

Teig 1 (Hovedteig)
234 / 99

Målestokk 1:250
EUREF89 UTM Sone 32

FLYTE
BRYGGA

NAVST 49,5 m²
+234 / 99

6727320

6727310

6727300

6727290

306390

306400

306410

306420

306430

306440

306450

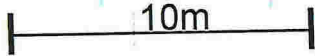

+234 / 10

+234 / 11

+234 / 3

+234 / 5