

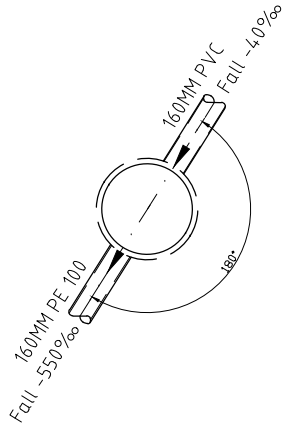

S28 - ϕ 600

H=1,10m



S29 - ϕ 600

H=2,0m

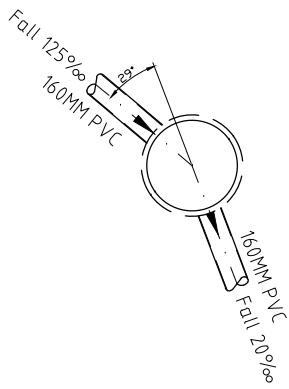

O29 - ϕ 600

H=1,99m

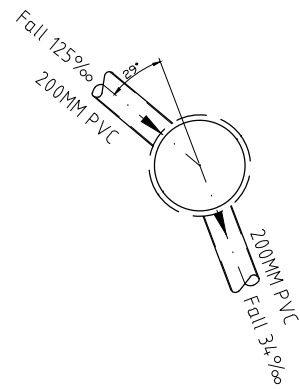

S30 - ϕ 600

H=1,46m

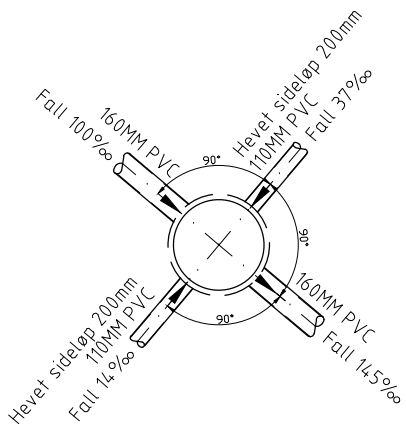

O30 - ϕ 600

H=1,47m

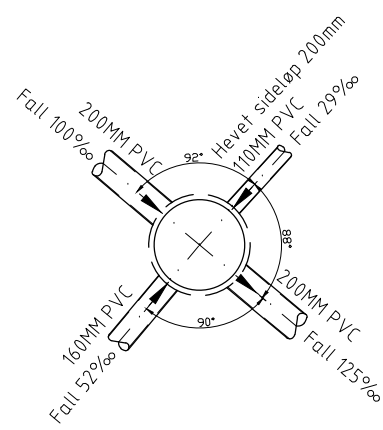

S31 - ϕ 600

H=1,55m

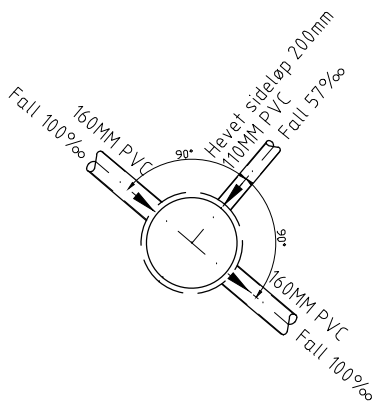

O31 - ϕ 600

H=1,56m

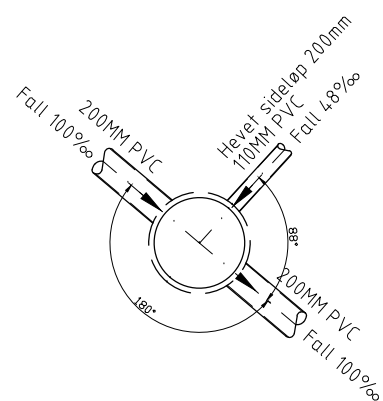

ARBEIDSTEGNING

Rev.	A	Dato	09.08.17	Sign.	THF	Høyde kummer. ARBEIDSTEGNING		
Oppdragsgiver						Revisjonen gjelder		
SOMMERRO PANORAMA AS						Tegn. Kontr. Godkj.		
Kubbaleitet bustadområde.						THF	THF	
Kumskjema S28-31 og O29-31.						Dato: 28.04.17		
haugen VVA						Målestokk: 1:50 A3		
Fabrikkgaten 7B 5059 Bergen Tlf. 55 59 82 60 e-post: post@haugenvva.no						Prosjektnr. 8116		
						Tegningsnr. GH35		Rev. A