

1 Etasje
1 : 100

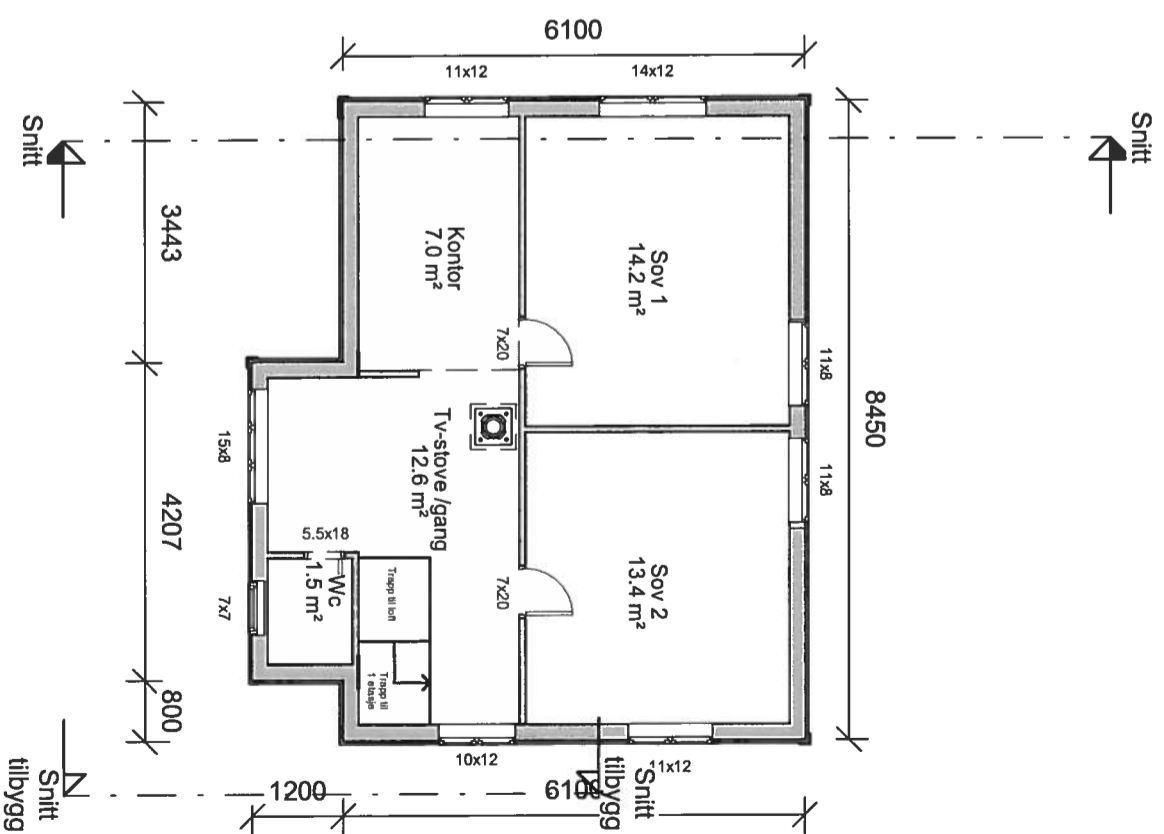

2 Etasje
1 : 100

Areal bya	11.4 m ²
Tilbygg	

Areal bra	9.4 m ²
Tilbygg	

BYA Toaltalt	Area	130.0
Navn	Areal (m2)	

BRA Totalt	
Navn	Areal (m2)
Kjeller	
Area	43.2
1 Etasje	
Area	70.1
2 Etasje	
Area	50.1
Loft	
Area	14.7
178.2	

REV.	DATO	REVISJON	SIGN.

Kållås Bygg AS
Torhusmyrane 2, 5913 Eikangervåg
MESTERHUS

TILTAKSHAVER:	Harald Andre Martinussen
BYGGERPLASS:	Fyllingsnesvegen 216
G.nr/B.nr:	214/214
KOMMUNE:	Lindås

TEGN. INNHOLD:	Plan 1 og 2 etasje	TILTAKSART:	Enebolig	MAL:	1 : 100
PROSJEKT:	Eksisterende bolig	TEGN.:	ET	PROSJEKT NR.:	TEGN.NR. 09.04
ARKITEKT:	ET	DATO:	22.11-18		

Kjeller

1 : 100

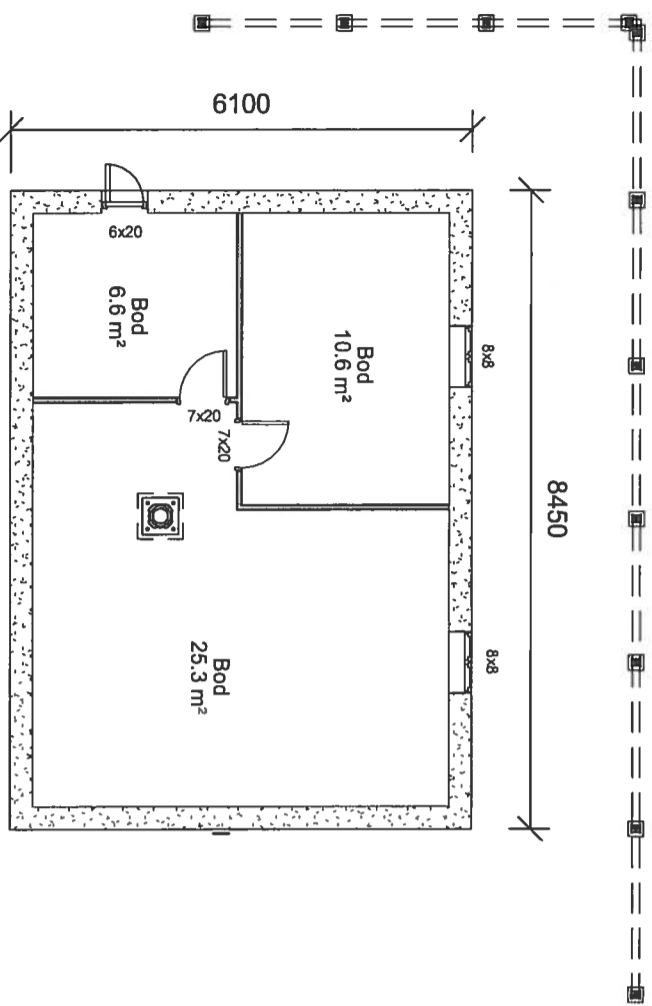

Loft

1 : 100

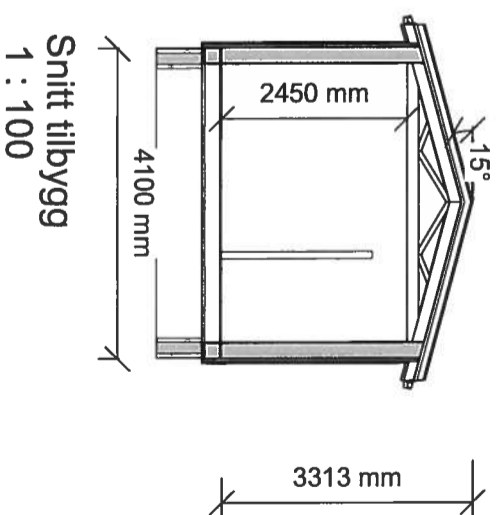
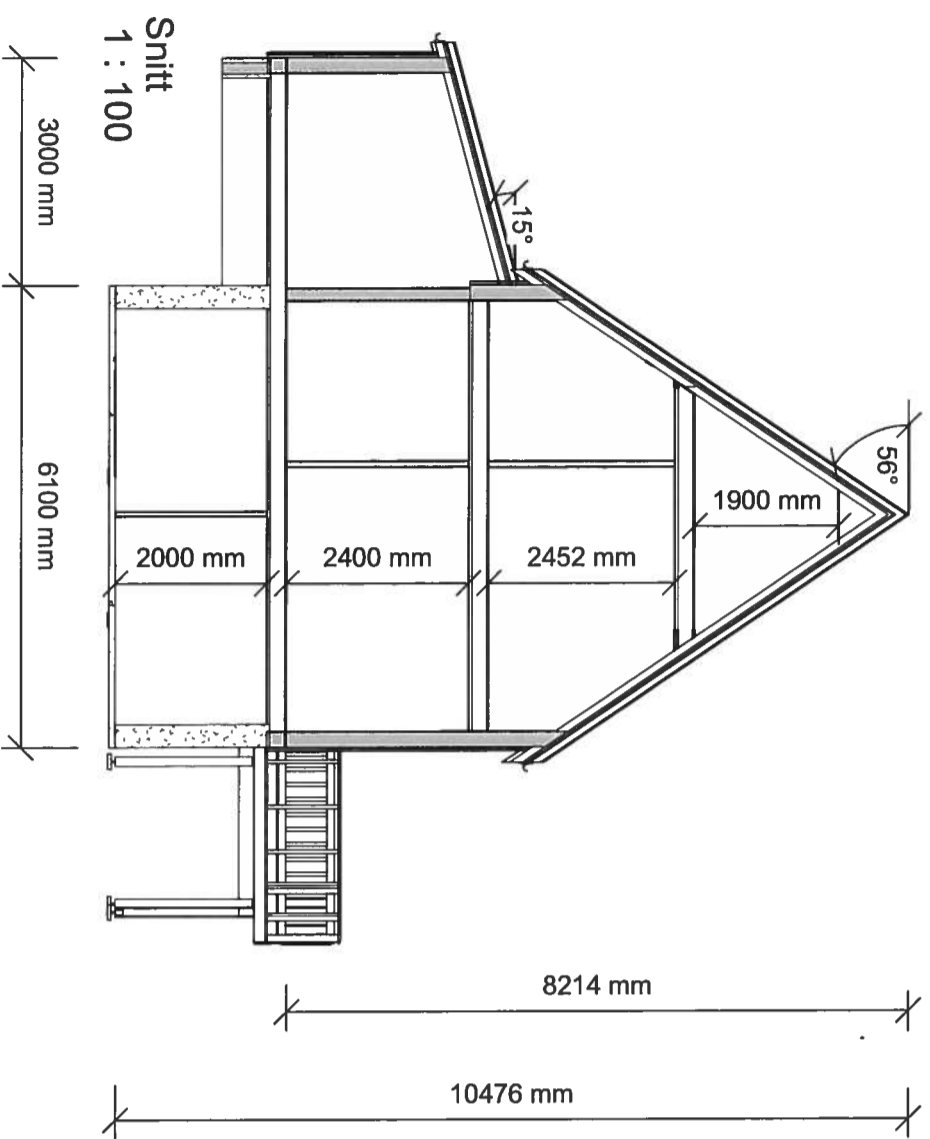
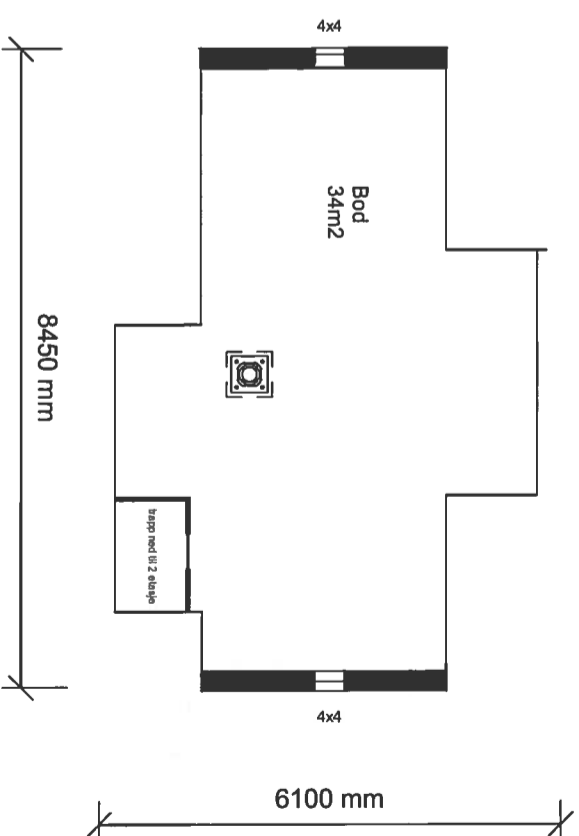

REV.	DATO	REVISJON	SIGN

Kålas Bygg AS
 Tomhusmyrane 2, 5913 Eikangervåg
MESTERHUS

TILTAKSHAVER:	Harald Andre Martinussen
BYGGERPLASS:	Fyllingsnesvegen 216
G.nr/B.nr:	214/214
KOMMUNE:	Lindås

TEGN. INNHOLD:	Kjeller, loft og snitt	TILTAKSART:	Enebolig	MAL:	1 : 100
PROSJEKT:	Eksisterende bolig	TEGN:	Author	PROSJEKT NR.:	TEGN NR.:
ARKTEKT:	ET	DATO:	11/22/18	PROSJEKT NR.:	TEGN NR.:
					09.05

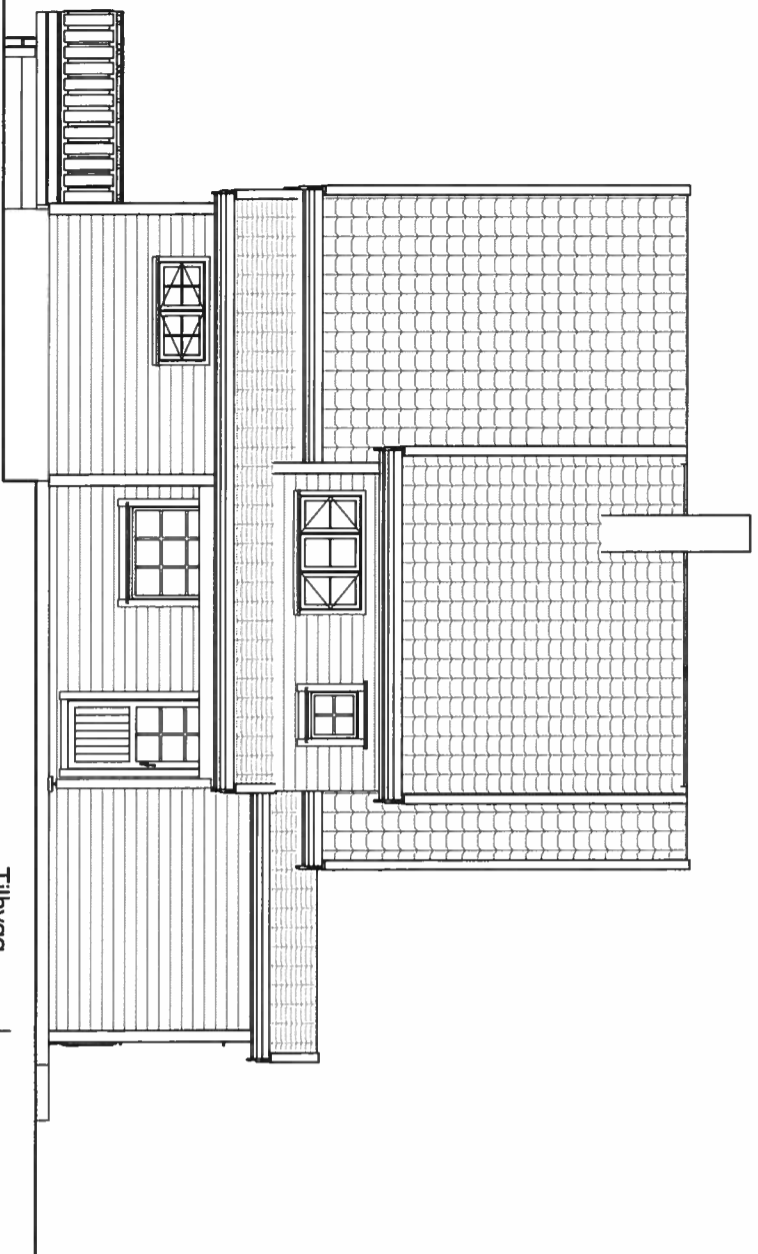

FASADE MOT VEST
1 : 100

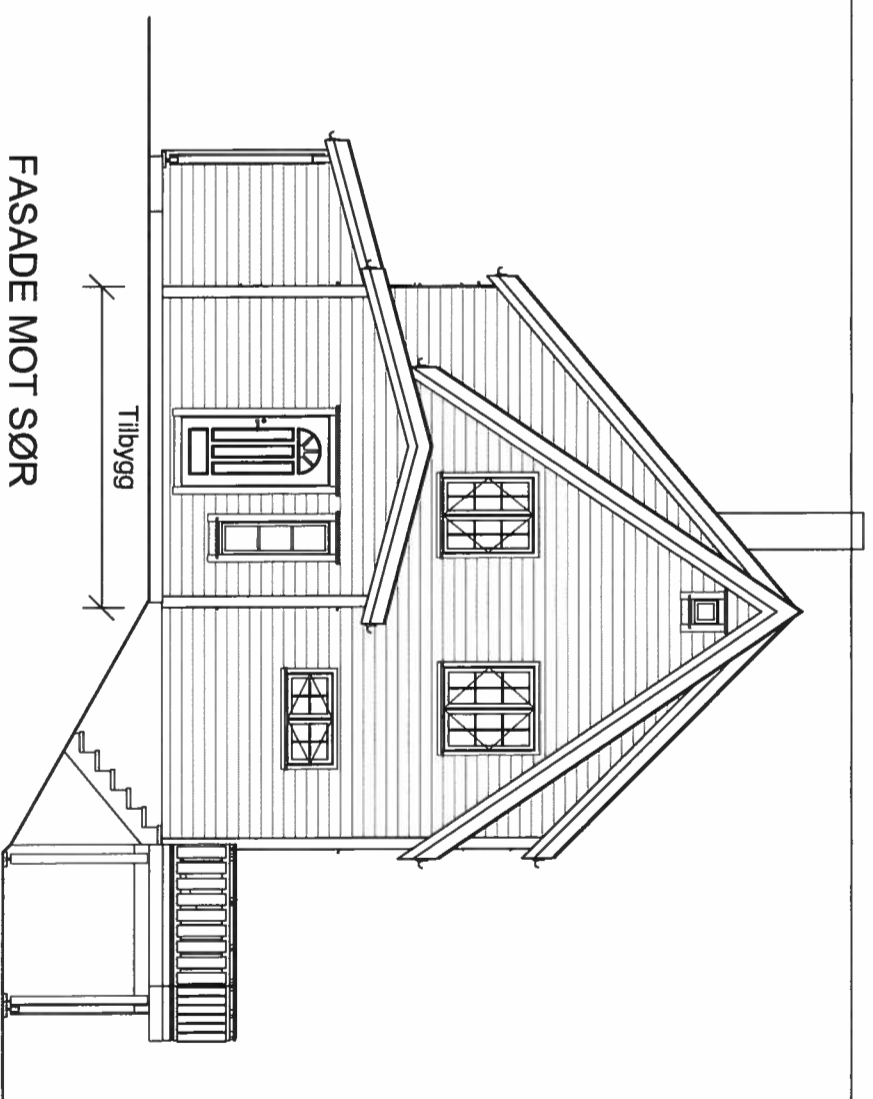

FASADE MOT SØR
1 : 100

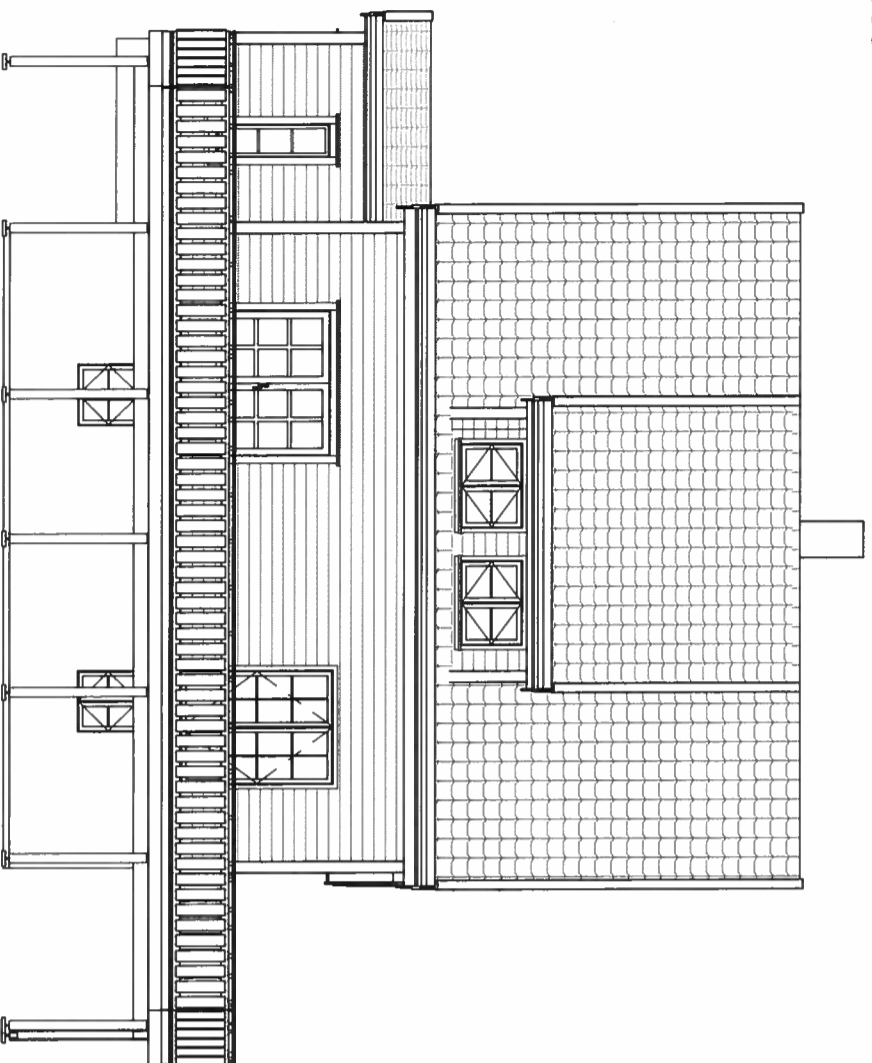

FASADE MOT NORD ØST
1 : 100

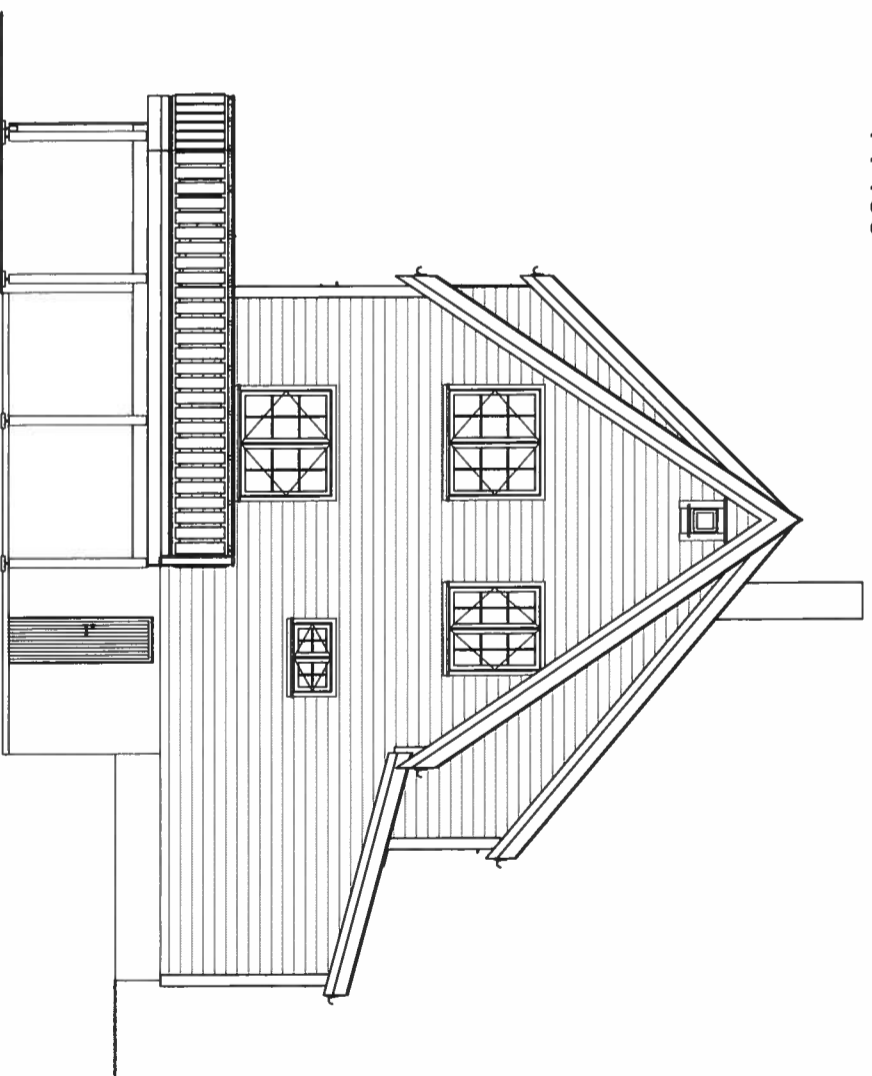

FASADE MOT NORD VEST
1 : 100

REV.	DATO	REVISJON	SIGN.

Kålås Bygg AS
Tomhusmyrane 2, 5913 Eikangervåg
MESTERHUS

TILTAKSHAVER:	Harald Andre Martinussen
BYGGERPLASS:	Fyllingsnesvegen 216
G.nr/B.nr:	214/214
KOMMUNE:	Lindås

TEGN. INNHOLD:	Fasader	TILTAKSART:	Enebolig	MAL:	1 : 100
PROSJEKT:	Eksisterende bolig	ARKTEKT:	ET	PROSJEKT NR.:	TEGN.NR. 09.06
DATE:	11/22/18	TEGN:	Author		